

Miomir K. Vukobratović

Contribution to the study of anthropomorphic systems

Kybernetika, Vol. 8 (1972), No. 5, (404)--418

Persistent URL: <http://dml.cz/dmlcz/125702>

Terms of use:

© Institute of Information Theory and Automation AS CR, 1972

Institute of Mathematics of the Academy of Sciences of the Czech Republic provides access to digitized documents strictly for personal use. Each copy of any part of this document must contain these

Terms of use.



This paper has been digitized, optimized for electronic delivery and stamped with digital signature within the project *DML-CZ: The Czech Digital Mathematics Library*
<http://project.dml.cz>

Contribution to the Study of Anthropomorphic Systems

MIOMIR VUKOBRATOVIĆ

This contribution treats definitions, dynamic aspects and stability concepts of anthropomorphic systems. In addition to general conclusions about the new method of two-legged systems modelling, there are given some characteristic schemes of perturbed steady gait regime stabilization.

METHOD OF ARTIFICIAL SYNERGY SYNTHESIS

The basic problem of the artificial locomotion system synthesis consists in the elaboration of corresponding synergies, enabling to reduce the number of control coordinates. This problem reduces to the elaboration of control algorithms, which have to ensure relative movement of the whole locomotion system or of its parts, according to some prescribed law.

It is known that the legged locomotion systems represent complex space systems with a great number of degrees of freedom. The attempt to synthesize a locomotion mechanism, reproducing with great similarity the human locomotion system, would lead to extremely complex systems, particularly from the control standpoint.

It is sufficient to remind of the fact that the upper extremities of man contain 52 muscle pairs, the lower extremities 62 pairs, back — 112 pairs, chest part — 52 pairs, pelvic part — 8 pairs. The neck contains 16 pairs and the head itself 25 pairs of muscles. The whole muscular system is able to control human motions with amazing complexity, enabling him to perform an almost arbitrary skeletal activity.

It is understandable that at the present level of technical progress it is not possible to control an artificial system containing about 400 double-acting actuators (800 muscles).

Evidently, there arises the problem how to reduce the total number of degrees of freedom at the dynamic level of the locomotion — manipulation system. In connection with this, there exist different attempts to reduce the dimensionality during the synthesis of the system for artificial skeletal activity as compared with the natural system.

One of these [1] reduces the skeletal activity to a very limited number of movements, using at this electrical stimulation of the natural locomotion system. Another approach studies the legged locomotion dynamics on a rigid body model with six degrees of freedom [2, 3], moving under the effect of alternate force impulses. These impulses arise as the result of alternate leg contact with the supporting surface. The limitation of this approach evidently lies in the fact, that leg masses have not been taken into account, although, as it is known, they represent roughly half of the total system mass.

In the proposed method the synergy of some type of gait is been realized as well as the synthesis of the compensating system, which is necessary to maintain the prescribed synergy [4, 5]. The synergy supposes the synchronization of the system parts relative movement and it is equivalent to introducing supplementary connections (constraints) in the locomotion system mechanism. Due to these connections the total number of degrees of freedom diminishes considerably, and with a prescribed algorithm the system does not possess "freedom" in the classical sense; it moves according to a preselected law.

The synergy in question is being realized in different ways for the lower extremities and the upper part of the body. For the lower extremities a periodic algorithm is prescribed imitating human gait. The upper body algorithm can be acquired from the gait repeatability conditions [4].

With the synthesis of artificial synergy, important role is played by the dynamic links. So we will nominate some differential relations to be satisfied during the gait. Particularly, they can be in the form of some relations, posed upon reactions on the support surfaces of the feet.

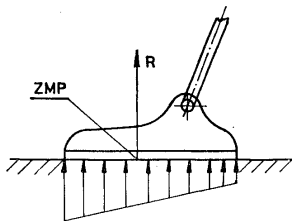

Fig. 1. Zero-moment point (ZMP).

In Fig. 1 an example of force distribution across the foot is given in the form of a diagram. As the charge has the same sign all over the surface, it can be reduced to the resultant force R , the point of attack of which will be in the boundaries of the foot. Let the point on the surface of the foot, where the resultant R passes, be denoted as the zero-moment point, or ZMP in short.

In the case of the double support phase, ZMP can find itself outside the support surface of the feet (dashed zone in Fig. 2). In the boundaries of this zone ZMP can move according to various laws, which define the gait to a considerable extent. The

basic idea in the synthesis of synergy lies in prescribing the ZMP movement laws in advance. For instance, in the single support phase, ZMP is in the center of the support surface of the foot, while in the double support phase translates itself gradually or stepwise into the other foot surface center. If we denote with λ the point ZMP, according to D'Alembert's principle the sum of the external and inertial forces' moments relative to that point should be zero. Analogously, the law of the friction forces change can be prescribed, for instance, demanding that the friction forces moment be zero at point, λ . This renders one more equation of dynamic connections.

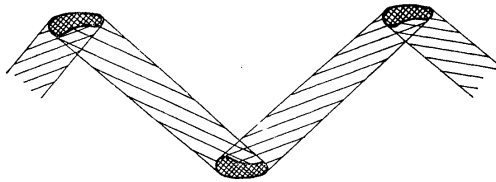

Fig. 2. Admissible region of ZMP position.

For the model considered we shall set motion laws of the model "legs" (that is, all coordinates $\beta_i(t)$, see Fig. 3) and from equations of dynamic connections with respect to the coordinates of the body upper portion (coordinates ψ, θ).* Then, differential equations of dynamic connections (more details see eqs. (12), (13)) can be written in the following symbolic form:

$$(1) \quad \begin{aligned} Q\dot{Y} + Q_1 &= 0, \\ Y &= (\psi, \theta, \dot{\psi}, \dot{\theta}) \end{aligned}$$

where Y — vector of phase coordinates.

Matrices Q and Q_1 depend on vector Y and on set synergy $\beta_i(t)$, as well:

$$\begin{aligned} Q &= Q(Y, \beta, \dot{\beta}, \ddot{\beta}), \\ Q_1 &= Q_1(Y, \beta, \dot{\beta}, \ddot{\beta}). \end{aligned}$$

* Dynamic connections represent the equations of moment written for the system connected to the zero moment point. Under the realistic supposition that a sufficient friction moment exists at the contact point between the foot and support, the dynamic connections are reduced to two equations of moment round the axes of coordinates, x and y . Thus the conditions of dynamic equilibrium of the locomotion system are obtained, that provide a stable gait in the saggittal and frontal plane

$$\begin{aligned} M_x &\equiv 0, \\ M_y &\equiv 0. \end{aligned}$$

Let T be the step period. Let us denote with

$$Y(0) = Y^0 \quad \text{and} \quad Y(T) = Y^T$$

the phase coordinates at the beginning and end of step.

Now the repeatability conditions can be presented by the following functional relation:

$$(2) \quad Y^T = \chi(Y^0).$$

Only those solutions of system (2), satisfying conditions (3) are of interest for consideration. The phase coordinate vector at the beginning of step for that case let us denote with \bar{Y}^0 .

Keeping in mind that the boundary conditions are given in the form of the functional relation (2) it is necessary to form an algorithm for automatic solution obtaining of the coupled system (1, 2), for the case that these solutions are existing.

For this reason let us introduce the performance index of fulfilling conditions (2).

Let $\bar{Y}(t)$ be some solution of (1) not satisfying relation (2). As before, let us denote

$$\bar{Y}(0) = \bar{Y}^0, \quad \bar{Y}(T) = \bar{Y}^T.$$

As the performance index, let us introduce the relation:

$$(3) \quad J = \|\bar{Y}^T - \chi(\bar{Y}^0)\|.$$

As \bar{Y}^T and \bar{Y}^0 are correlated by differential equation (2), J is a function of \bar{Y}^0 only

$$J = J(\bar{Y}^0)$$

It is evident that the repeatability conditions are now equivalent to:

$$(4) \quad J(\bar{Y}^0) = \min_{\bar{Y}^0} J(\bar{Y}^0) = 0.$$

In order to solve (4), the gradient method can be applied [7]:

$$(5) \quad \bar{Y}_{i+1}^0 = \bar{Y}_i^0 - \varepsilon \nabla J$$

where $\nabla J = \text{grad } J(\bar{Y}^0)$, i - number of iteration steps.

In the cases when the phase coordinate vector \bar{Y}^0 is sufficiently near to the nominal value Y^0 , the following local method can be introduced [4, 5].

Let the deviation $\Delta Y^0 = \bar{Y}^0 - Y^0$ be sufficiently small. This deviation causes a small deviation $\Delta Y^T = \bar{Y}^T - Y^T$ at the end of the step. Now the expression (2) can be written as:

$$(6) \quad \bar{Y}^T + \Delta Y^T = \chi(\bar{Y}^0 + \Delta Y^0).$$

408 The correlation between the deviation at the beginning and end of step can be expressed as:

$$(7) \quad \Delta Y^T = \frac{\partial Y^T}{\partial Y^0} \Delta Y^0$$

where the members of the matrix $|\partial Y^T / \partial Y^0|$ are calculated in the point $Y^0 = \bar{Y}^0$.

By solving systems (6) and (7) the sought value $\Delta \bar{Y}^0$ can be found

$$(8) \quad \Delta \bar{Y}^0 = \Phi(\bar{Y}^0).$$

If J is changing strictly monotonously, the method explained can be used also in the cases, in which the value of the phase coordinate \bar{Y}^0 differs considerably from the nominal value \bar{Y}^0 . The obtaining of the repeatability conditions in such a case is effected more efficiently by the gradient method (5). The monotonous change of J can be ascertained by choosing ε sufficiently small in the following relation:

$$(9) \quad \bar{Y}_{i+1}^0 = \bar{Y}_i^0 + \varepsilon \Phi(\bar{Y}_i^0).$$

In order to accelerate the process of obtaining the repeatability conditions, it is advisable to use combined criteria (6) and (10). The transfer from criterion (5) to (9) should be done when J becomes smaller than J^* , where J^* is a predetermined value of the performance index (3).

In compliance with the physical nature of gait, conditions (2) can be written in the form:

$$(10) \quad Y^0 = \eta Y^T$$

where the lower index denotes the number of the phase coordinate. In the general case matrix η has the form:

$$(11) \quad \eta = \begin{bmatrix} 1 & 0 & 0 & \dots & 0 \\ 0 & -1 & 0 & \dots & 0 \\ \dots & \dots & \dots & \dots & \dots \\ 0 & \dots & \dots & \dots & 1 \end{bmatrix}.$$

SYNERGY GENERATION

In order to be able to investigate gait stability we are going to form the mathematical model, describing the locomotion structure dynamics, represented in Fig. 3.

The upper part of the locomotion structure is regarded in the form of an inverted pendulum. The lower extremities have feet and each extremity has three degrees of freedom; the segments are interconnected by simple joints. For leg movement a "real" gait algorithm is adopted. In Fig. 4 some of the diagrams are given, representing

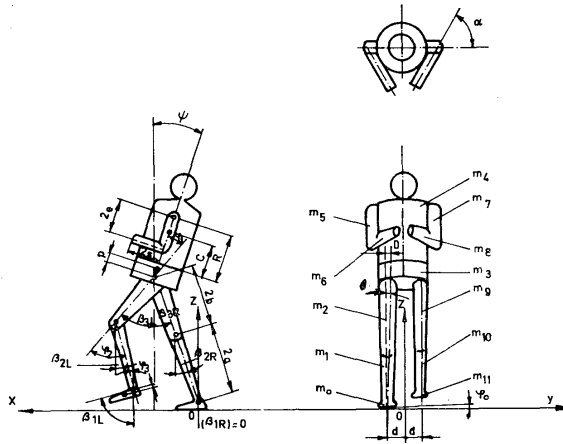

Fig. 3. Mechanical biped model.

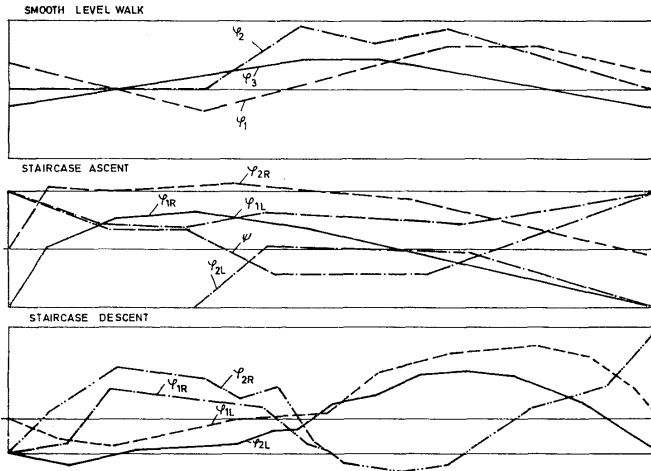

Fig. 4. Typical synthetic gait algorithms.

gait upon level ground, upstairs and downstairs, which have been synthesized based upon data, acquired from biometrical investigations. The chosen gait types are characterized by a very "smooth" behaviour of the locomotion system pelvic part. This supposition is of purely practical nature, because the applicability of these results to exoskeleton type biped robots is kept in mind.

According to the chosen gait algorithm, the supporting foot transfers from heel to toes as illustrated in Fig. 5. In this case, three phases can be separated, corresponding to the positions in Fig. 5. Let us designate with t_{ab} the moment of support passing from heel to the whole foot and with t_{bc} the corresponding moment of support passing from whole foot to the toes ($0 < t_{ab} < t_{bc} < T/2$) where T — full step period.

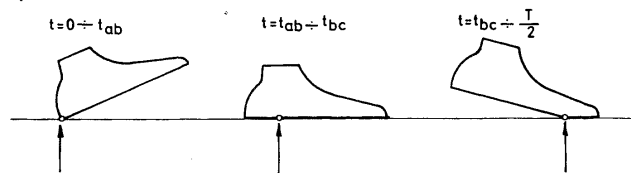

Fig. 5. Supporting point changes.

During the half-period, the zero-moment point "jumps" three times to a new position: at the end of the first phase from the heel to the "center" of the foot, and at the end of the second phase from that position to the toes (Fig. 5). At the end of the half-period, the zero-moment point passes over under the other foot, which is in contact with the ground. It should be stressed out, that such a transfer of the point of support has made the gait smoother to a certain extent. However, an even more natural gait* can be realized by prescribing the zero-moment point trajectory, corresponding to the double-support phase, which is not going to be treated here.

Under the supposition that we dispose with the kinematic algorithm (chosen gait type) and the zero-moment point trajectory we can proceed to obtain the upper part dynamic algorithm. Let us write the equations of dynamic connections using D'Alambert's principle. These equations are formed according to the general form (1). For the chosen gait algorithm (Fig. 4) angular displacements of the structure pelvic part are practically not existing. If we additionally suppose that the friction moment on the supporting foot is sufficiently great to ensure planar motion of the lower extremities, we can neglect the third differential equation of system (1), describing the system dynamic equilibrium round the z -axis. Here x_i, y_i, z_i — coordinates

* In this case, the gait comprises the movement of the lower extremities themselves (kinematic algorithm), as well as the movement of the locomotion system compensation part (dynamic algorithm).

of mass center of the i -th segment. Other denotations are evident from Fig. 3.

411

$$(12) \quad M_y \equiv \bar{\theta} \left[\sum_{i=1}^{11} m_i (V_i z_i - R_i x_i) \right] + \bar{\psi} \left[\sum_{i=1}^{11} m_i (W_i z_i - S_i x_i) + J_{y4} + J_{y5} + \right. \\ \left. + J_{y6} + J_{y7} + J_{y8} \right] + \sum_{i=1}^{11} m_i (P_i z_i - T_i x_i) - g \sum_{i=1}^{11} m_i x_i + \\ + J_{y1} \beta_{2L} + J_{y2} \beta_{1L} + J_{y9} \beta_{1R} + J_{y10} \beta_{2R} + J_{y11} \beta_{3R} = 0,$$

$$(13) \quad M_x \equiv \bar{\theta} \left[\sum_{i=1}^{11} m_i (R_i J_i - A_i z_i) + J_{x1} + J_{x2} + J_{x9} + J_{x10} + J_{x11} \right] + \\ + \bar{\psi} \sum_{i=1}^{11} m_i S_i y_i + \sum_{i=1}^{11} m_i (T_i y_i - C_i z_i) + g \sum_{i=1}^{11} m_i y_i = 0,$$

where

$$\begin{aligned} V_1 &= -a \sin \theta \sin \beta_{2L}, \\ V_2 &= 2V_1 - b \sin \theta \sin \beta_{1L}, \\ V_3 &= V_2 - b \sin \theta \sin \beta_{1L}, \\ V_4 &= V_3, \quad V_5 = V_3, \quad V_6 = V_3, \quad V_7 = V_5, \quad V_8 = V_6, \\ V_9 &= V_3 - b \sin \theta \sin \beta_{1R}, \\ V_{10} &= V_3 - (2b \sin \beta_{1R} + a \sin \beta_{2R}) \sin \theta, \\ V_{11} &= V_3 - (2b \sin \beta_{1R} + 2a \sin \beta_{2R} + h \sin \beta_{3R}) \sin \theta; \\ W_1 &= 0, \quad W_2 = 0, \quad W_3 = 0, \\ W_4 &= c \cos \bar{\psi}, \quad W_5 = (R - e) \cos \bar{\psi}, \\ W_6 &= (R - 2e) \cos \bar{\psi} - s \cos \alpha \sin \bar{\psi}, \\ W_7 &= W_5, \quad W_8 = W_6, \quad W_9 = 0, \quad W_{10} = 0, \quad W_{11} = 0; \\ P_1 &= -a \theta^2 \cos \theta \sin \beta_{2L} - a \theta \beta_{2L} \sin \theta \cos \beta_{2L} + a \beta_{2L} \cos \theta \cos \beta_{2L} - \\ &\quad - a \beta_{2L} \bar{\theta} \sin \theta \cos \beta_{2L} - a \beta_{2L} \cos \theta \sin \beta_{2L}, \\ P_2 &= 2P_1 - b \theta^2 \cos \theta \sin \beta_{1L} - b \theta \beta_{1L} \sin \theta \cos \beta_{1L} + b \beta_{1L} \cos \theta \cos \beta_{1L} - \\ &\quad - b \beta_{1L} \bar{\theta} \sin \theta \cos \beta_{1L} - b \beta_{1L}^2 \cos \theta \sin \beta_{1L}, \\ P_3 &= P_2 - \theta^2 b \cos \theta \sin \beta_{1L} - \theta \beta_{1L} b \sin \theta \cos \beta_{1L} + b \beta_{1L} \cos \theta \cos \beta_{1L} - \\ &\quad - b \beta_{1L} \bar{\theta} \sin \theta \cos \beta_{1L} - b \beta_{1L}^2 \cos \theta \sin \beta_{1L}, \\ P_4 &= P_3 - c \bar{\psi}^2 \sin \psi, \quad P_5 = P_3 - (R - e) \bar{\psi}^2 \sin \bar{\psi}, \\ P_6 &= P_3 - (R - 2e) \bar{\psi}^2 \sin \bar{\psi} - s \bar{\psi}^2 \cos \alpha \cos \bar{\psi}, \\ P_7 &= P_5, \quad P_8 = P_6, \\ P_9 &= P_3 - b \theta^2 \cos \theta \sin \beta_{1R} - 2b \theta \beta_{1R} \sin \theta \cos \beta_{1R} + b \beta_{1R} \cos \theta \cos \beta_{1R} - \\ &\quad - b \beta_{1R}^2 \cos \theta \sin \beta_{1R}, \\ P_{10} &= P_3 + (2b \beta_{1R} \cos \alpha_{1R} - 2b \beta_{1R}^2 \sin \beta_{1R} + a \beta_{2R} \cos \beta_{2R} - a \beta_{2R}^2 \sin \beta_{2R}) \cos \theta - \\ &\quad - 2\bar{\theta} (2b \beta_{1R} \cos \beta_{1R} + a \beta_{2R} \cos \beta_{2R}) \sin \theta - \\ &\quad - \theta^2 (2b \sin \beta_{1R} + a \sin \beta_{2R}) \cos \theta, \end{aligned}$$

$$\begin{aligned}
412 \quad P_{11} &= P_3 + (2b\beta_{1R} \cos \beta_{1R} - 2b\beta_{1R}^2 \sin \beta_{1R} + 2a\beta_{2R} \cos \beta_{2R} - 2a\beta_{2R}^2 \sin \beta_{2R} + \\
&\quad + h\beta_{3R} \cos \beta_{3R} - h\beta_{3R}^2 \sin \beta_{3R}) \cos \theta - 2\theta(2b\beta_{1R} \cos \beta_{1R} + 2a\beta_{2R} \cos \beta_{2R} \\
&\quad + h\beta_{3R} \cos \beta_{3R}) \sin \theta - \theta^2(2b \sin \beta_{1R} + 2a \sin \beta_{2R} + h \sin \beta_{3R}) \cos \theta ; \\
A_1 &= a \cos \beta_{2R} \cos \theta , \\
A_2 &= 2A_1 + b \cos \beta_{1L} \cos \theta , \\
A_3 &= A_2 + b \cos \beta_{1L} \cos \theta , \\
A_4 &= A_3 , \quad A_5 = A_3 , \quad A_6 = A_3 , \quad A_7 = A_3 , \quad A_8 = A_3 , \\
A_9 &= A_3 - b \cos \beta_{1R} \cos \theta , \\
A_{10} &= A_3 - (2b \cos \beta_{1R} + a \cos \beta_{2R}) \cos \theta , \\
A_{11} &= A_3 - (2a \cos \beta_{2R} + 2b \cos \beta_{1R} + h \cos \beta_{3R}) \cos \theta ; \\
C_1 &= -a\beta_{2L} \sin \beta_{2L} \sin \theta - a\beta_{2L}^2 \cos \beta_{2L} \sin \theta - a\beta_{2L} \theta \sin \beta_{2L} \cos \theta - \\
&\quad - a\theta\beta_{2L} \sin \beta_{2L} \cos \theta - a\theta^2 \cos \beta_{2L} \sin \theta , \\
C_2 &= 2C_1 - b\beta_{1L} \sin \beta_{1L} \sin \theta - b\beta_{1L}^2 \cos \beta_{1L} \sin \theta - 2b\beta_{1L} \theta \sin \beta_{1L} \cos \theta - \\
&\quad - b\theta^2 \cos \beta_{1L} \sin \theta , \\
C_3 &= C_2 - b\beta_{1L} \sin \beta_{1L} \sin \theta - b\beta_{1L}^2 \cos \beta_{1L} \sin \theta - 2b\beta_{1L} \theta \sin \beta_{1L} \cos \theta - \\
&\quad - b\theta^2 \cos \beta_{1L} \sin \theta , \\
C_4 &= C_3 , \quad C_5 = C_3 , \quad C_6 = C_3 , \quad C_7 = C_3 , \quad C_8 = C_3 , \\
C_9 &= C_3 + b\beta_{1R} \sin \beta_{1R} \sin \theta + b\beta_{1R}^2 \cos \beta_{1R} \sin \theta + 2b\beta_{1R} \theta \sin \beta_{1R} \cos \theta + \\
&\quad + b\theta^2 \cos \beta_{1R} \sin \theta , \\
C_{10} &= C_3 + (2b\beta_{1R} \sin \beta_{1R} + 2b\beta_{1R}^2 \cos \beta_{1R} + a\beta_{2R} \sin \beta_{2R} + \\
&\quad + a\beta_{2R}^2 \cos \beta_{2R}) \sin \theta + 2\theta(2b\beta_{1R} \sin \beta_{1R} + a\beta_{2R} \sin \beta_{2R}) \cos \theta + \\
&\quad + \theta^2(2b \cos \beta_{1R} + a \cos \beta_{2R}) \sin \theta , \\
C_{11} &= C_3 + (2a\beta_{2R} \sin \beta_{2R} + 2a\beta_{2R}^2 \cos \beta_{2R} + 2b\beta_{1R} \sin \beta_{1R} + \\
&\quad + 2b\beta_{1R}^2 \cos \beta_{1R} + h\beta_{3R} \sin \beta_{3R} + h\beta_{3R}^2 \cos \beta_{3R}) \sin \theta + \\
&\quad + 2\theta(2a\beta_{2R} \sin \beta_{2R} + 2b\beta_{1R} \sin \beta_{1R} + h\beta_{3R} \sin \beta_{3R}) \cos \theta + \\
&\quad + \theta^2(2a \cos \beta_{2R} + 2b \cos \beta_{1R} + h \cos \beta_{3R}) \sin \theta ; \\
R_1 &= -a \cos \beta_{2L} \sin \theta , \\
R_2 &= -(2a \cos \beta_{2L} + b \cos \beta_{1L}) \sin \theta , \\
R_3 &= R_2 - b \cos \beta_{1L} \sin \theta , \\
R_4 &= R_3 , \quad R_5 = R_3 , \quad R_6 = R_3 , \quad R_7 = R_5 , \quad R_8 = R_6 , \\
R_9 &= R_3 + b \cos \beta_{1R} \sin \theta , \quad R_{10} = R_R + (b \cos \beta_{1R} + a \cos \beta_{2R}) \sin \theta , \\
R_{11} &= R_{10} + a \cos \beta_{2R} \sin \theta ; \\
S_1 &= S_2 = S_3 = 0 , \quad S_4 = -c \sin \bar{\psi} , \\
S_5 &= -(R - e) \sin \bar{\psi} , \quad S_6 = -[(R - 2e) \sin \bar{\psi} + s \cos \alpha \cos \bar{\psi}] , \\
S_7 &= S_5 , \quad S_8 = S_6 , \quad S_9 = S_{10} = S_{11} = 0 ; \\
T_1 &= -a[\beta_{2L} \sin \beta_{2L} \cos \theta + \beta_{2L}^2 \cos \beta_{2L} \cos \theta - 2\beta_{2L} \theta \sin \beta_{2L} \sin \theta + \\
&\quad + b\theta^2 \cos \beta_{2L} \cos \theta] ,
\end{aligned}$$

$$\begin{aligned}
 T_2 &= -(2a\beta_{2L} \sin \beta_{2L} + 2a\beta_{2L}^2 \cos \beta_{2L} + b\beta_{1L} \sin \beta_{1L} + b\beta_{1L}^2 \cos \beta_{1L}) \cos \theta + \\
 &\quad + 2\theta(2a\beta_{2L} \sin \beta_{2L} + b\beta_{1L} \sin \beta_{1L}) \sin \theta - \theta^2(2a \cos \beta_{2L} + b \cos \beta_{1L}) \cos \theta, \\
 T_3 &= T_2 - b\beta_{1L} \sin \beta_{1L} \cos \theta - b\beta_{1L}^2 \cos \beta_{1L} \cos \theta + 2b\theta\beta_{1L} \sin \beta_{1L} \sin \theta - \\
 &\quad - \theta^2 \cos \beta_{1L} \cos \theta, \\
 T_4 &= T_3 - c\tilde{\psi}^2 \cos \tilde{\psi}, \\
 T_5 &= T_3 - \tilde{\psi}^2(R - e) \cos \tilde{\psi}, \\
 T_6 &= T_3 - \tilde{\psi}^2[(R - 2e) \cos \tilde{\psi} - s \cos \alpha \sin \tilde{\psi}], \\
 T_7 &= T_5, \quad T_8 = T_6 \\
 T_9 &= T_3 + b\beta_{1R} \sin \beta_{1R} \cos \theta + b\beta_{1R}^2 \cos \beta_{1R} \cos \theta - 2b\theta\beta_{1R} \sin \beta_{1R} \sin \theta + \\
 &\quad + b\theta^2 \cos \beta_{1R} \cos \theta, \\
 T_{10} &= T_9 - 2\theta(b\beta_{1R} \sin \beta_{1R} + a\beta_{2R} \sin \beta_{2R}) \sin \theta + \\
 &\quad + (b\beta_{1R} \sin \beta_{1R} + b\beta_{1R}^2 \cos \beta_{1R} - a\beta_{2R} \sin \beta_{2R} - a\beta_{2R}^2 \cos \beta_{2R}) \cos \theta + \\
 &\quad + \theta^2(b \cos \beta_{1R} + a \cos \beta_{2R}) \cos \theta, \\
 T_{11} &= T_{10} + a\beta_{2R} \sin \beta_{2R} \cos \theta + a\beta_{2R}^2 \cos \beta_{2R} \cos \theta - 2a\theta\beta_{2R} \sin \beta_{2R} \sin \theta + \\
 &\quad + a\theta^2 \cos \beta_{2R} \cos \theta.
 \end{aligned}$$

These equations have been written for a support point when ZMP corresponds to the contact with “whole” foot. As ZMP displaces itself according to the already mentioned law, Fig. 5, the translation of the coordinate system should be taken care of.

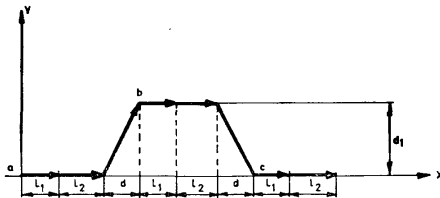

Fig. 6. Schematic presentation of coordinates changes.

It has to be noted, as well, that the eqs. (12), (13) for the model in Fig. 3 are presented for the purpose of illustrating the method of set synergy. At the same time, such a model can also satisfy completely the practical objectives in locomotion studying. In order to obtain the mathematical model systematically, let us suppose that equations (12) and (13) describe the first supporting phase (heel strike). So when passing to the second phase, all x -coordinates should be reduced by the value l_1 (Fig. 6). When passing to the third phase the same coordinates should be once more reduced, but this time by the value l_2 . Finally, when the support passes to the other foot, the x -coordinates should be reduced by the value d and the y -coordinates change their value abruptly by d_1 (Fig. 6). The segment abc on the graph Fig. 6 corresponds to full step (period T), whilst segment ab corresponds to half step.

Due to system symmetry only half of the step can be considered. The repeatability conditions in that case will be:

$$Y^0 = \begin{bmatrix} -1 & 0 & 0 & 0 \\ 0 & 1 & 0 & 0 \\ 0 & 0 & -1 & 0 \\ -0 & 0 & 0 & 1 \end{bmatrix} Y^T$$

where

$$Y = \begin{Bmatrix} \theta \\ \psi \\ \theta \\ \psi \end{Bmatrix}.$$

In this case the performance index J and the expressions for J has the form.

$$(15) \quad J(Y^0) = [(Y_1^0 + Y_1^T)^2 + (Y_2^0 - Y_2^T)^2 + (Y_3^0 + Y_3^T)^2 + (Y_4^0 - Y_4^T)^2]^{1/2},$$

$$\nabla J = \{\nabla_1 J, \nabla_2 J, \nabla_3 J, \nabla_4 J\},$$

$$(16) \quad \nabla_1 J = \left[(Y_1^0 + Y_1^T) \left(1 + \frac{\Delta Y_1^T}{\Delta Y_1^0} \right) - (Y_2^0 - Y_2^T) \frac{\Delta Y_2^T}{\Delta Y_1^0} + (Y_3^0 + Y_3^T) \frac{\Delta Y_3^T}{\Delta Y_1^0} - (Y_4^0 - Y_4^T) \frac{\Delta Y_4^T}{\Delta Y_1^0} \right] / J,$$

$$\nabla_2 J = \left[(Y_1^0 + Y_1^T) \frac{\Delta Y_1^T}{\Delta Y_2^0} + (Y_2^0 - Y_2^T) \left(1 - \frac{\Delta Y_2^T}{\Delta Y_2^0} \right) + (Y_3^0 + Y_3^T) \frac{\Delta Y_3^T}{\Delta Y_2^0} - (Y_4^0 - Y_4^T) \frac{\Delta Y_4^T}{\Delta Y_2^0} \right] / J,$$

$$\nabla_3 J = \left[(Y_1^0 + Y_1^T) \frac{\Delta Y_1^T}{\Delta Y_3^0} - (Y_2^0 - Y_2^T) \frac{\Delta Y_2^T}{\Delta Y_3^0} + (Y_3^0 + Y_3^T) \left(1 + \frac{\Delta Y_3^T}{\Delta Y_3^0} \right) - (Y_4^0 - Y_4^T) \frac{\Delta Y_4^T}{\Delta Y_3^0} \right] / J,$$

$$\nabla_4 J = \left[(Y_1^0 + Y_1^T) \frac{\Delta Y_1^T}{\Delta Y_4^0} - (Y_2^0 - Y_2^T) \frac{\Delta Y_2^T}{\Delta Y_4^0} + (Y_3^0 + Y_3^T) \frac{\Delta Y_3^T}{\Delta Y_4^0} + (Y_4^0 - Y_4^T) \left(1 - \frac{\Delta Y_4^T}{\Delta Y_4^0} \right) \right] / J.$$

Starting from these expressions, the function Φ from the relation (8) becomes:

$$\Phi = [A]^{-1} q$$

where

$$(17) \quad q = [-Y_1^T - Y_1^0, Y_2^0 - Y_2^T, -Y_3^T - Y_3^0, Y_4^0 - Y_4^T],$$

and

$$(18) \quad A = \begin{bmatrix} \frac{\Delta Y_1^T}{\Delta Y_1^0} + 1 & \frac{\Delta Y_1^T}{\Delta Y_2^0} & \frac{\Delta Y_1^T}{\Delta Y_3^0} & \frac{\Delta Y_1^T}{\Delta Y_4^0} \\ \frac{\Delta Y_2^T}{\Delta Y_1^0} & \frac{\Delta Y_2^T}{\Delta Y_2^0} - 1 & \frac{\Delta Y_2^T}{\Delta Y_3^0} & \frac{\Delta Y_2^T}{\Delta Y_4^0} \\ \frac{\Delta Y_3^T}{\Delta Y_1^0} & \frac{\Delta Y_3^T}{\Delta Y_2^0} & \frac{\Delta Y_3^T}{\Delta Y_3^0} + 1 & \frac{\Delta Y_3^T}{\Delta Y_4^0} \\ \frac{\Delta Y_4^T}{\Delta Y_1^0} & \frac{\Delta Y_4^T}{\Delta Y_2^0} & \frac{\Delta Y_4^T}{\Delta Y_3^0} & \frac{\Delta Y_4^T}{\Delta Y_4^0} - 1 \end{bmatrix}$$

By simultaneously solving systems (12), (13), (14) and the sensitivity equations (8), using expressions (17) and (18), the locomotion system upper body algorithm can be obtained, satisfying the repeatability conditions.

On the basis of the described method, repeatability conditions can be obtained, representing in fact the calculated synergy of the rest of the system (dynamic algorithm), based upon the prescribed synergy of one part of the system (kinematic

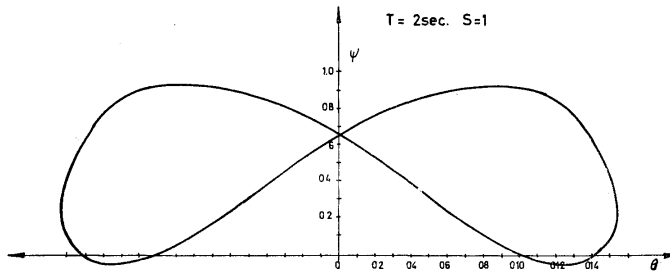

Fig. 7. Nominal gait trajectory for biped model with fixed upper extremities.

algorithm). One of the characteristic diagrams in the phase plane of two compensating coordinates ψ and θ in the form of a closed curve, represents in fact the satisfied repeatability conditions (Fig. 7). The curve has been obtained for characteristic parameters of the locomotion system $S = 1$, $T = 2$ sec, where S - coefficient of kinematic algorithm amplitude scaling (parameter of step length), and T - step period (parameter of gait speed).

In the preceding text it was shown in short how the synergy of the complete system is being formed. As it was shown, for one part the synergy was prescribed and for the other part it was calculated using the dynamic analysis. Consequently, as a result, we possess the relative coordinates $\varphi_i(t)$, i.e. the complete synergy ensuring periodic gait. This synergy has been defined for "ideal" conditions, under the supposition that no perturbations are acting on the locomotion system in consideration.

Under ideal conditions there exist periodic change laws $\beta_i(t)$, corresponding to the $\varphi_i(t)$ laws, where $\beta_i(t)$ as compared with $\varphi_i(t)$ define the positions of the locomotion system elements in relation to a fixed absolute coordinate system. For this reason, let us introduce the concept of internal synergy for $\varphi_i(t)$ and external synergy for $\beta_i(t)$.

In the case of perturbation, even with very strict fulfilling of the internal synergy $\varphi_i(t)$, the external synergy can be perturbed. For instance, the whole system can rotate round the supporting foot, which causes the angles $\beta_i(t)$ to change.

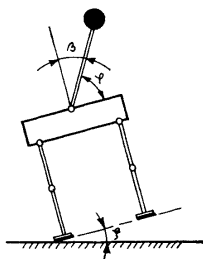

Fig. 8. Front view of the locomotion system.

For illustration purposes, the side view of the locomotion system is shown in Fig. 8. Due to some external perturbation the model can pass to some position, in which support is on the edge of the foot. Let us denote the angle between the foot and support with ξ . If in the case of absence of perturbations the external synergy $\beta_i(t)$ was defined by the internal synergy $\varphi_i(t)$ only, for instance for the model upper part:

$$\beta = \frac{\Pi}{2} - \varphi$$

in the presence of perturbations, $\beta_i(t)$ becomes

$$\beta = \frac{\Pi}{2} - \varphi - \xi.$$

If due to any reason the internal synergy $\varphi_i(t)$ is not being realized, this state reflects itself in the external synergy $\beta_i(t)$. On the other hand, external synergy (and not internal) defines a repeatable gait in the relation to an absolute coordinate system.

Consequently, under stable gait we will understand such a gait, in which external synergy tends to the "ideal" synergy, which has been defined in the absence of perturbations.

Let us now formalize this concept and make it more precise. We introduce the following designations. With the upper index "0" denote the coordinate change laws, obtained from ideal conditions. We will call them "ideal" coordinates. Consequently, φ^0 and β^0 represent the ideal internal synergy, whilst φ and θ correspond to the real synergy.

Let us suppose that for some reason the internal synergy of the system has been perturbed and that φ differs from φ^0 . In that case two cases can be distinguished. In the first one, the model can possess a stability margin [8, 9] due to its geometrical properties, i.e. it will be tending to the ideal external synergy in the case of small perturbations.

The second case is characterized by the fact, that the stability margin is insufficient (or even non-existent) so for dynamic equilibrium maintaining special compensating movements of the system are needed.

This paper has not treated the problems of synthesizing the compensating system for maintaining a stable gait in the presence of perturbations that surpass the capability of the auto-stability of the anthropomorphic system, that is, its stability margin. They are dealt with detail in [9].

(Received December 13, 1971.)

REFERENCES

- [1] Tomović R., Bellman R.: Systems Approach to Muscle Control. *Mathematical Biosciences* 8 (1970), 314.
- [2] McGhee R.: Some Finite State Aspects of Legged Locomotion. *Mathematical Biosciences* 2 (1968), 2.
- [3] Frank A., McGhee R.: Some Considerations Relating to the Design of Autopilots of Legged Vehicles. *Journal of Terramechanics* 6 (March, 1969), 1.
- [4] Vukobratović M., Juričić D.: Contribution to the Synthesis of Biped Gait, *IEEE Trans. Biomedical Engineering BME-16* (January 1969).
- [5] Vukobratović M., Frank A., Juričić D.: On the Stability of Biped Locomotion. *Trans. IEEE Biomedical Engineering BME-17* (January 1970).
- [6] Bernstein N. A.: Očerki po fizilogii dviženij i fiziologii aktivnosti (Notes on the Physiology of Motion and Activity). "Medecina", Moscow 1966.
- [7] Vukobratović M., Čirič V., Hristić D.: Control of Two-Legged Locomotion Systems, Proc. of IV IFAC Symposium on Automatic Control in Space, Dubrovnik 1971.
- [8] Frank A. A., Vukobratović M.: On the Synthesis of a Biped Locomotion Machine. Presented at the 8th International Conference of Medical and Biological Engineering, Evanston, Ill., July 20—25, 1969.
- [9] Vukobratović M., Stepanenko Y.: On the Stability of Anthropomorphic Systems. *Mathematical Biosciences* 4 (October 1972).

Příspěvek ke studiu antropomorfních systémů

MIOMIR VUKOBRATOVIČ

V článku se probírají definice, dynamické aspekty a koncepce stability antropomorfních systémů. Kromě obecných závěrů o nové metodě modelování dvouno-
hých systémů jsou probírána některá charakteristická schémata stabilizace ustáleného
režimu chůze za přítomnosti poruch.

*Miomir Vukobratović, Ph.D., Institute for Automation and Telecommunications „Mihailo
Pupin“, P. O. Box 906, 11001 Beograd, Yugoslavia.*