

Ivan Havel; Jaroslav Morávek

*B*-valuations of graphs

*Czechoslovak Mathematical Journal*, Vol. 22 (1972), No. 2, 338–351

Persistent URL: <http://dml.cz/dmlcz/101102>

## Terms of use:

© Institute of Mathematics AS CR, 1972

Institute of Mathematics of the Czech Academy of Sciences provides access to digitized documents strictly for personal use. Each copy of any part of this document must contain these *Terms of use*.



This document has been digitized, optimized for electronic delivery and stamped with digital signature within the project *DML-CZ: The Czech Digital Mathematics Library* <http://dml.cz>

## B-VALUATIONS OF GRAPHS<sup>1)</sup>

IVAN HAVEL, JAROSLAV MORÁVEK, Praha

(Received July 12, 1971)

### 1. INTRODUCTION

Let  $G = \langle V, E \rangle$  be a finite undirected graph without loops and multiple edges, let  $\mathbf{B}^n$  be the set of all  $n$ -dimensional vectors (where  $n \geq 1$  is an integer) whose components are zero or one. An injection  $\varphi$  of  $V$  into  $\mathbf{B}^n$  will be called  $B_n$ -valuation of the graph  $G$ , iff for any two adjacent vertices  $u, v$  in  $G$ , their images  $\varphi(u), \varphi(v)$  differ exactly in one component. We say that  $G$  allows a  $B$ -valuation iff there are an integer  $n$  and a  $B_n$ -valuation of  $G$ . Any  $B_n$ -valuation of  $G$  is its  $B$ -valuation.

The starting and stimulating point for the study of graphs allowing  $B$ -valuations lies in the theory of automata. It is important to know, when coding internal states of some automaton (especially in an asynchronous case), whether or not it may be performed in such a way that the codes of any two states allowing an immediate transition from one to another, differ exactly at one place. Briefly, one has to decide whether or not the state diagram of the automaton allows a  $B$ -valuation, cf. [3].

Our main task in this paper is to give a contribution to the study of  $B$ -valuations of graphs. In section 2 we discuss certain necessary and sufficient conditions the graph must fulfil in order to allow a  $B$ -valuation. Their immediate corollaries and examples of graphs allowing a  $B$ -valuation are also presented here. Further examples (both positive and negative) and also definitions of main concepts of the theory for the case of infinite graphs are contained in section 3. Section 4 contains the main result of the paper: to any integer  $q$  we construct a bipartite graph of the girth  $2q$  (the girth of a graph = the length of its shortest circuit), not allowing a  $B$ -valuation. Section 5 consists of concluding remarks.

---

<sup>1)</sup> The paper was presented at the Summer school on Number Theory and Graph Theory in Modra-Piesok which was organized by Association of Slovak Mathematicians in May, 25–29, 1970.

## 2. NECESSARY AND SUFFICIENT CONDITIONS

For simplicity let us introduce two algebraic structures on  $\mathbf{B}^n$ . We define a binary operation  $\oplus$  on  $\mathbf{B}^n$  (which is frequently called "componentwise addition modulo 2") in the following way: if  $\mathbf{x}, \mathbf{y} \in \mathbf{B}^n$ ,  $\mathbf{x} = (x_1, \dots, x_n)$ ,  $\mathbf{y} = (y_1, \dots, y_n)$ , then  $\mathbf{x} \oplus \mathbf{y} = \mathbf{z}$ ,  $\mathbf{z} = (z_1, \dots, z_n)$  where  $z_i = 1$  if  $x_i \neq y_i$  and  $z_i = 0$  if  $x_i = y_i$ . The set  $\mathbf{B}^n$  together with the operation  $\oplus$  is an Abelian group denoted in the sequel by  $\mathfrak{G}^n$ . Obviously, a neutral element of  $\mathfrak{G}^n$  is a "zero vector"  $\mathbf{0} = (0, \dots, 0)$  while the index of any other element of  $\mathfrak{G}^n$  is 2. Hence the equality  $\mathbf{x} \oplus \mathbf{y} = \mathbf{0}$  in  $\mathfrak{G}^n$  holds iff  $\mathbf{x} = \mathbf{y}$ .

Another algebraic structure on  $\mathbf{B}^n$  is obtained by means of "adjacency" relation. Two vectors  $\mathbf{x} = (x_1, \dots, x_n)$ ,  $\mathbf{y} = (y_1, \dots, y_n)$  from  $\mathbf{B}^n$  are called *adjacent* iff there is an integer  $i$  ( $1 \leq i \leq n$ ) such that  $x_i \neq y_i$ , while  $x_j = y_j$  for  $j \neq i$ ,  $1 \leq j \leq n$ . The adjacency relation is symmetric and antireflexive; it defines on  $\mathbf{B}^n$  an undirected graph, denoted by  $\mathfrak{C}^n$  and usually called *n-dimensional unit cube*.

Let us put further

$$\mathbf{U}^n = \{ \mathbf{x} \in \mathbf{B}^n; \mathbf{x} = (x_1, \dots, x_n), \text{ there is just one } j (1 \leq j \leq n) \text{ such that } x_j = 1 \}.$$

Then for any  $\mathbf{x}, \mathbf{y} \in \mathbf{B}^n$ ,  $\mathbf{x}, \mathbf{y}$  are adjacent iff  $\mathbf{x} \oplus \mathbf{y} \in \mathbf{U}^n$ . Before stating the first necessary and sufficient condition, we need one more definition: an injection  $\chi$  of the set of edges  $E$  of the graph  $G = \langle V, E \rangle$  into the set of integers  $\{1, 2, \dots, n\}$  will be called a  $C_n$ -valuation of the graph  $G$ , iff the following conditions are fulfilled:

a) for any (closed) circuit of  $G$  and any  $j \in \{1, 2, \dots, n\}$ , the set of all the edges of  $G$ , to which the number  $j$  is assigned by  $\chi$ , is either empty or it has an even number of elements

b) for any (open) path of  $G$  there is an integer  $j \in \{1, 2, \dots, n\}$  such that the set of all the edges of  $G$  to which the number  $j$  is assigned by  $\chi$ , has an odd number of elements.

The condition b) may also be expressed as follows: the condition a) is fulfilled for no (open) path of  $G$ . We say that  $G$  allows a  $C$ -valuation iff there are an integer  $n$  and a  $C_n$ -valuation of  $G$ . Any  $C_n$ -valuation of  $G$  is its  $C$ -valuation.

Owing to the properties of the group  $\mathfrak{G}^n$  we are able to reformulate the conditions a) and b). Firstly, let us introduce a bijection  $\iota$  of  $\mathbf{U}^n$  onto  $\{1, 2, \dots, n\}$  as follows:

$$\iota(\mathbf{x}) = j \quad \text{iff} \quad \mathbf{x} = (x_1, \dots, x_n) \in \mathbf{U}^n \quad \text{and} \quad x_j = 1.$$

For any  $e \in E$  let us put further

$$\kappa(e) = \iota^{-1}[\chi(e)].$$

Since  $\chi$  maps  $E$  into  $\{1, 2, \dots, n\}$ ,  $\kappa$  maps  $E$  into  $\mathbf{U}^n$ . The conditions a) and b) of the definition of  $C$ -valuation can then be expressed as follows:

a') for the set of edges  $\{e_1, \dots, e_r\}$  of any (closed) circuit of  $G$ ,

$$\varkappa(e_1) \oplus \varkappa(e_2) \oplus \dots \oplus \varkappa(e_r) = \mathbf{0}.$$

b') for the set of edges  $\{f_1, \dots, f_s\}$  of any (open) path of  $G$ ,

$$\varkappa(f_1) \oplus \varkappa(f_2) \oplus \dots \oplus \varkappa(f_s) \neq \mathbf{0}.$$

The next theorem yields the first necessary and sufficient condition the graph must fulfil in order to allow a  $B$ -valuation, cf. [3].

**Proposition 1.** (i) *If  $G$  allows a  $B_n$ -valuation, then it also allows a  $C_n$ -valuation. If a connected graph  $G$  allows a  $C_n$ -valuation, it also allows a  $B_n$ -valuation.*

(ii)  *$G$  allows a  $B$ -valuation iff it allows a  $C$ -valuation.*

*Proof.* First we prove the (i) part. Let  $G = \langle V, E \rangle$  allow a  $B_n$ -valuation  $\varphi : V \rightarrow \mathbf{B}^n$ . Thus, for any pair  $u, v \in V$  of adjacent vertices

$$\varphi(u) \oplus \varphi(v) \in \mathbf{U}^n.$$

Let us put

$$\chi(e) = \iota(\varphi(u) \oplus \varphi(v))$$

for any  $e \in E$ ,  $e$  incident with the vertices  $u, v$ . Then  $\chi$  maps  $E$  into  $\{1, 2, \dots, n\}$ ; it is easy to show that  $\chi$  is a  $C_n$ -valuation of  $G$ .

Assume now  $G$  to be connected and to allow a  $C_n$ -valuation  $\chi$ . We shall construct its  $B_n$ -valuation. Choose any vertex  $v_0$  in  $G$  and define a mapping  $\varphi : V \rightarrow \mathbf{B}^n$  as follows:  $\varphi(v_0) = \mathbf{0}$ ; if  $v \neq v_0$  and  $e_1, \dots, e_r$  is an edge-sequence of any path from  $v_0$  to  $v$ , then

$$\varphi(v) = \varkappa(e_1) \oplus \varkappa(e_2) \oplus \dots \oplus \varkappa(e_r)$$

(where  $\varkappa(e) = \iota^{-1}(\chi(e))$ ). It can be easily proved that  $\varphi(v)$  does not depend on the choice of the path from  $v_0$  to  $v$  (i.e. the definition of  $\varphi$  is correct), and that  $\varphi$  is a  $B_n$ -valuation.

From (i) the necessity in (ii) easily follows. In order to prove the sufficiency, we have to construct a  $B$ -valuation of a disconnected graph  $G$  when some of its  $C_n$ -valuations is given. Let  $k$  be the number of connectivity components of  $G$ . Then it is possible to construct a  $B_{n+m}$ -valuation where  $m \geq ]\lg_2 k[{}^2$  of  $G$  as follows: in each component the construction of  $B_n$ -valuation is carried out in a way described in the proof of (i). Thereafter, vectors assigned to the vertices of different connectivity components are distinguished from each other by means of additional  $m$  components ( $m \geq ]\lg_2 k[$ ).

<sup>2)</sup>  $]a[ = -[-a]$  is a well-known "post-office" function, i.e. the least integer greater or equal than  $a$ .

We derive several simple corollaries from Proposition 1:

**Corollary 1.** *If  $G$  allows a  $B$ -valuation, then  $G$  is bipartite.*

**Corollary 2.** *Every tree allows a  $B$ -valuation.*

**Corollary 3.** *A circuit allows a  $B$ -valuation iff it has an even length.*

Following [2], we introduce the following concept: A maximum (with respect to the inclusion) subgraph of  $G$  is called *lobe graph*, iff each pair of its distinct edges is contained in at least one circuit. Notice that 1) each circuit of  $G$  is contained in just one of its lobe graphs and

2) each edge of  $G$  is contained in just one of its lobe graphs.

Now we have

**Corollary 4.**  *$G$  allows a  $B$ -valuation, iff each of its lobe graphs allows a  $B$ -valuation.*

Before stating the second necessary and sufficient condition for the existence of  $B$ -valuation, we need the following definition:

we say that a graph  $G = \langle V, E \rangle$  is *embeddable in*  $G' = \langle V', E' \rangle$  (or that  $G$  is a *partial subgraph* of  $G'$  (cf. [1])), iff there is an injection  $\pi$  of the set  $V$  into  $V'$  preserving the adjacency relation, i.e. if  $(u, v) \in E$ , then  $(\pi(u), \pi(v)) \in E'$ .

Now, one can easily prove the following obvious statement:

**Proposition 2.**  *$G$  allows a  $B_n$ -valuation (resp. a  $B$ -valuation) iff it is embeddable in a  $n$ -dimensional unit cube  $\mathfrak{C}^n$  (resp. iff there is an integer  $n$  such that  $G$  is embeddable in  $\mathfrak{C}^n$ ).*

### 3. EXAMPLES

In this section we want to show (by means of examples of graphs both allowing and not allowing a  $C$ -valuation) the methods and reasoning utilized when  $C$ -valuations are to be constructed or when one is asked to prove that no  $C$ -valuation exists at all. According to Corollary 1 all the graphs considered here are bipartite.

Example 1. A complete bipartite graph  $K_{2,3}$  (see Fig. 1) does not allow a  $C$ -valuation.

Indeed, if there were a  $C$ -valuation of  $K_{2,3}$ , the edges incident with the vertex  $v_1$  would have to be assigned three different integers, say 1, 2, 3 (it

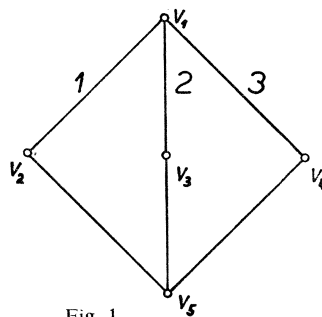

Fig. 1

follows from the condition b)). Consider the edge  $(v_3, v_5)$  as a part of the 4-circuit  $v_1, v_3, v_5, v_2$ . Then it must be assigned number 1. The same edge, considered as a part of the 4-circuit  $v_1, v_4, v_5, v_3$  must be assigned number 3, which is a contradiction.

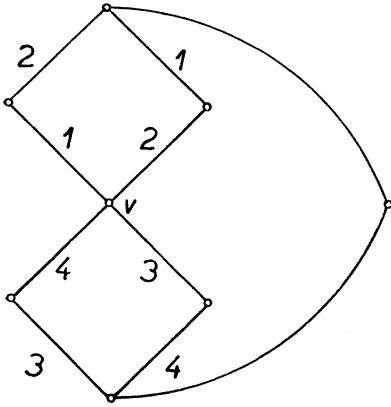

Fig. 2

Example 2. The graph of Fig. 2 does not allow a C-valuation.

Suppose, on the contrary, that there is a C-valuation of this graph. The edges incident with  $v$  must be assigned different numbers, say 1, 2, 3, 4 (cf. Fig. 2). Now the values of the remaining edges of both the 4-circuits are uniquely determined. By no means, however, one can fulfil the condition a) on the edges of both 6-circuits.

Example 3. We shall construct a countable class of graphs not allowing a C-valuation. A graph of this class is given by Fig. 3 (for  $l = 1$  one obtains  $K_{2,3}$ ).

Assume there is a C-valuation of the graph of Fig. 3. Then all the horizontal edges are assigned the same number, e.g. 1 (as follows from the condition a)). From the

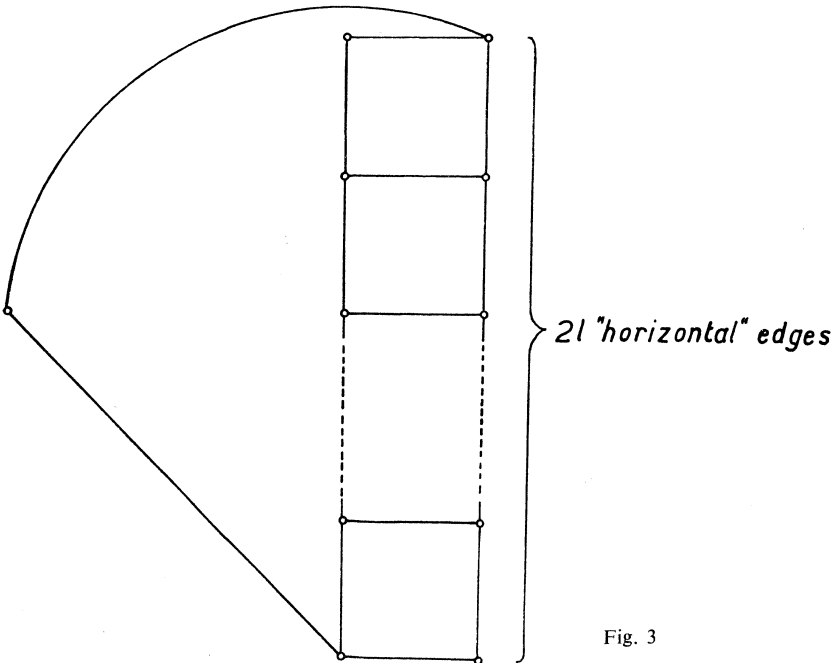

Fig. 3

condition b) we conclude that no vertical edge is assigned number 1. Out of the two remaining edges, just one has to be assigned number 1, which is, however, impossible, since both of them have a vertex in common with a 1-edge.

Graphs of examples 1–3 are s.c. *critical graphs not allowing a C-valuation*. (We call  $G$  critical, not allowing a C-valuation, if  $G$  itself does not allow a C-valuation, but  $G - e$  for any edge  $e$  does).

So far we were not interested in the following problem: “If  $G$  allows a C-valuation, what is the least integer  $n$  such that  $G$  allows a  $C_n$ -valuation?” We give an answer to the question for a very small class of trees in the next example.

Example 4. A snake  $S_n$  on  $n$  vertices (cf. Fig. 4) allows a  $C_{\lceil \lg_2 n \rceil}$ -valuation for  $n \geq 2$  and does not allow a  $C_{n'}$ -valuation for any  $n' < \lceil \lg_2 n \rceil$ .

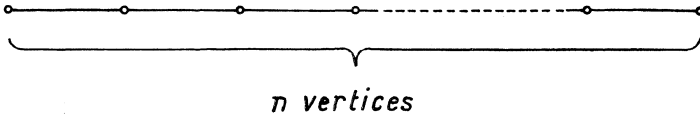

Fig. 4

Proof. Let there exist a  $C_{n'}$ -valuation of  $S_n$ . Then there is a  $B_{n'}$ -valuation of  $S_n$ . The latter, is however, an injection of the set of vertices (having  $n$  elements) into the set  $B^{n'}$  (having  $2^{n'}$  elements). Hence

$$2^{n'} \geq n, \quad \text{i.e.} \quad n' \geq \lceil \lg_2 n \rceil.$$

Now we have to show that there is a  $C_{\lceil \lg_2 n \rceil}$ -valuation of  $S_n$ . We carry out its construction by induction without loss of generality only for those  $S_n$  for which  $n = 2^v$  ( $v = 1, 2, 3, \dots$ ). Having constructed a  $C_v$ -valuation of  $S_{2^v}$ , take two equally valued copies of  $S_{2^v}$ , join one pair of their end-vertices by a new edge and obtain in this way  $S_{2^{v+1}}$ . The new edge will be assigned the number  $v + 1$ . The valuation of  $S_{2^{v+1}}$  obtained in this way is obviously a  $C_{v+1}$ -valuation of  $S_{2^{v+1}}$ .

Remark. Using the  $C_v$ -valuation of  $S_{2^v}$ , which has just been constructed, we can pass to  $B$ -valuations according to Proposition 1 and obtain in this way a sequence of all the vectors of  $B^n$  arranged in such a way that any two consecutive (and also the first and the last) differ exactly in one component. This sequence of vectors of  $B^n$  defines therefore a Hamiltonian circuit in an  $n$ -dimensional unit cube  $\mathbb{C}^n$ .

Let us now generalize the definitions of  $B$ - and  $C$ -valuations for the case of infinite graphs. We say that an infinite graph  $G$  allows a  $B$ -valuation (resp.  $C$ -valuation) iff any of its finite partial subgraph allows a  $B$ -valuation (resp.  $C$ -valuation). Obviously, also in the case of infinite graphs,  $G$  allows a  $B$ -valuation iff  $G$  allows a  $C$ -valuation.

Example 5. An infinite chess-board (a graph of Fig. 5) allows a  $C$ -valuation (cf. Fig. 5).

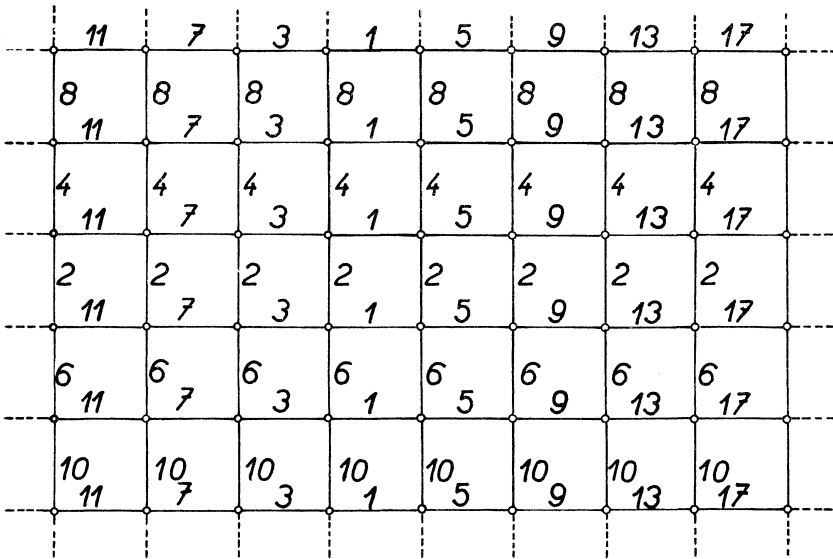

Fig. 5

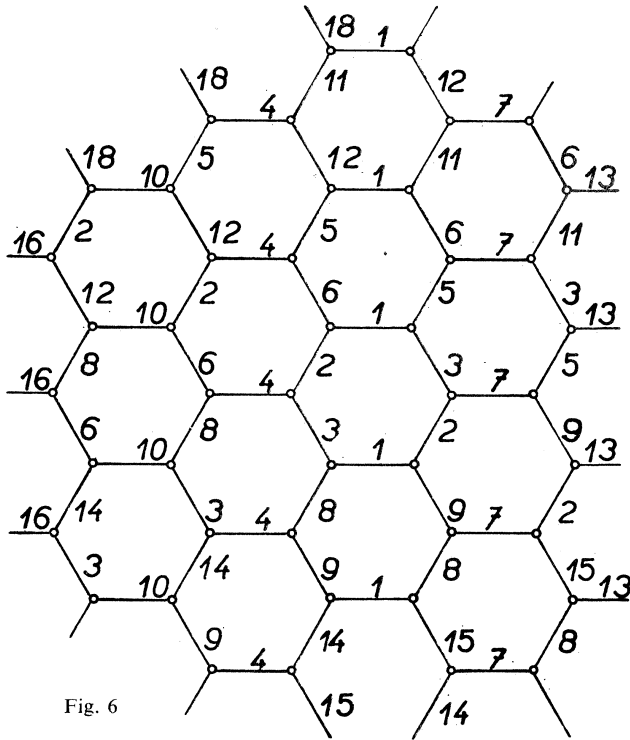

Fig. 6



Example 6. An infinite bee-cell-graph (given in Fig. 6) allows a C-valuation (cf. Fig. 6).

From Proposition 2 and Examples 5, 6 the following statement follows:

**Corollary.** Any finite partial subgraph of an infinite chessboard or an infinite bee-cell-graph is embeddable in a unite cube of a suitable dimension.

#### 4. GRAPHS OF ARBITRARILY LARGE GIRTH, NOT ALLOWING A C-VALUATION

In this section we are going to show (cf. Theorem) that there are bipartite graphs of arbitrarily large girth (the girth of a graph = the length of its shortest circuit) not allowing a C-valuation. Let us start with C-valuations of graphs of a certain simple class.

For  $n \geq 2$  and  $k \geq 1$  the graph given in Fig. 7 is called  $(n, k)$ -diamond and denoted by  $D_{n,k}$ .

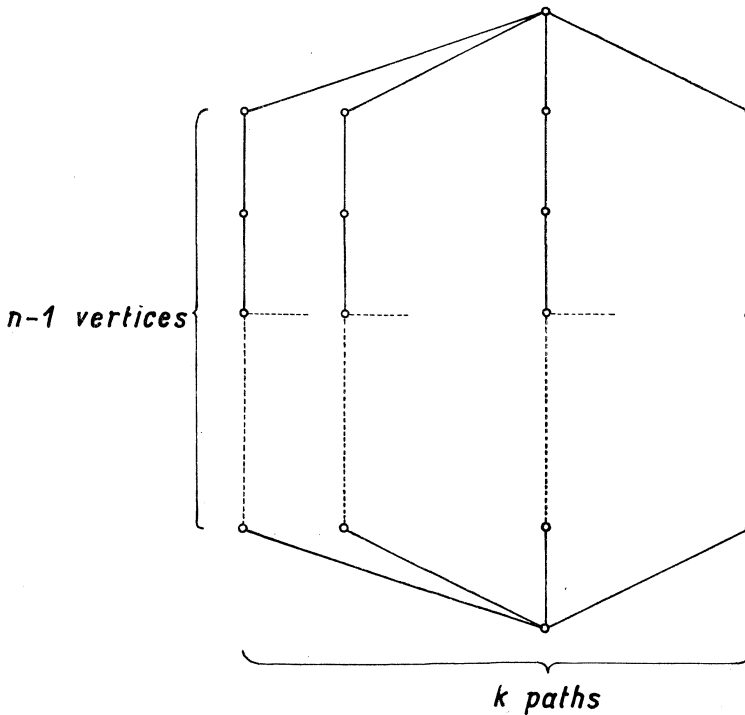

Fig. 7

$D_{n,k}$  has two vertices of degree  $k$  – we call them *poles* of the diamond – and  $k(n - 1)$  vertices of degree 2; its girth is obviously  $2n$ . We call *ribs* of  $D_{n,k}$  the  $k$  paths of the length  $n$  joining the poles of  $D_{n,k}$ .

**Proposition.** *If  $n \geq 3$  and  $k \geq 1$ , then  $D_{n,k}$  allows a C-valuation.  $D_{2,2}$  allows a C-valuation, too; if  $k \geq 3$ , then  $D_{2,k}$  does not allow a C-valuation.*

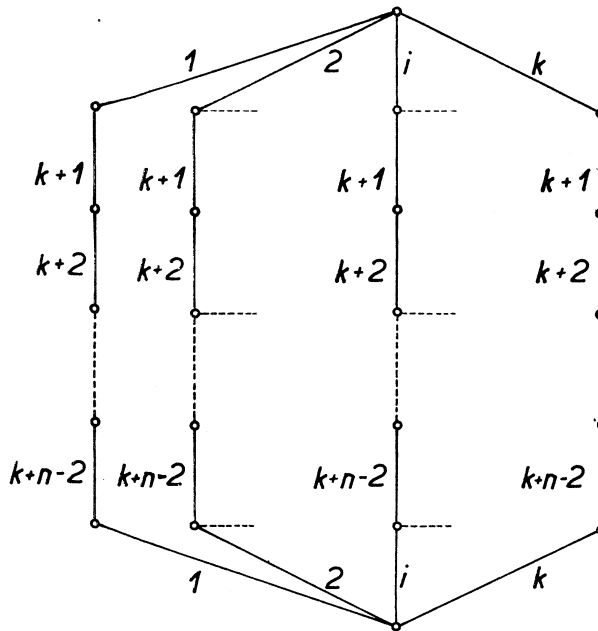

Fig. 8

**Proof.** One can easily see that the values assigned to edges of  $D_{n,k}$  ( $n \geq 3, k \geq 1$ ) in a way described by Fig. 8 form a C-valuation of  $D_{n,k}$ .  $D_{2,2}$  is a 4-circuit and as such it allows a C-valuation (Corollary 3), while  $D_{2,k}$  for  $k \geq 3$  contain  $K_{2,3}$  and thus do not allow a C-valuation.

Now we derive some properties of C-valuations of  $D_{n,k}$ . In what follows we assume  $n \geq 3$ . Let  $\chi$  be any C-valuation of  $D_{n,k}$ . The following statement is rather obvious: If the integer  $i$  occurs odd number of times on the edges of some rib (in a C-valuation  $\chi$ ), then it occurs on each rib of  $D_{n,k}$  and also odd number of times. (If  $i$  occurred e.g. on the rib  $r_1$  odd number of times and on the rib  $r_2$  even number of times, it would occur on the circuit  $r_1 r_2$  odd number of times, which is a contradiction).

We can, therefore, define

$$A(D_{n,k}, \chi) = \{i; i \text{ occurs on some rib of } D_{n,k} \text{ odd number of times}\}$$

$$o(D_{n,k}, \chi) = \text{card}(A(D_{n,k}, \chi)).$$

The following lemma summarizes basic properties of  $A(D_{n,k}, \chi)$  and  $o(D_{n,k}, \chi)$  which we shall need later on:

**Lemma 1.** *Let  $\chi$  be any C-valuation of  $D_{n,k}$ . Then*

- (i)  $o(D_{n,k}, \chi) \equiv n \pmod{2}$ ,  $0 < o(D_{n,k}, \chi) \leq n$ ,
- (ii) if  $k > n$ , then  $o(D_{n,k}, \chi) \leq n - 2$ ,
- (iii) if  $D_{n,k'}$  (where  $k'$  is a positive integer) is a “subdiamond” of  $D_{n,k}$  (i.e.  $D_{n,k'}$  arises from  $D_{n,k}$  by deleting some  $k - k'$  ribs),  $\chi'$  is a C-valuation of  $D_{n,k'}$  induced on it by  $\chi$ , then  $A(D_{n,k'}, \chi') = A(D_{n,k}, \chi)$  and therefore  $o(D_{n,k'}, \chi') = o(D_{n,k}, \chi)$ .

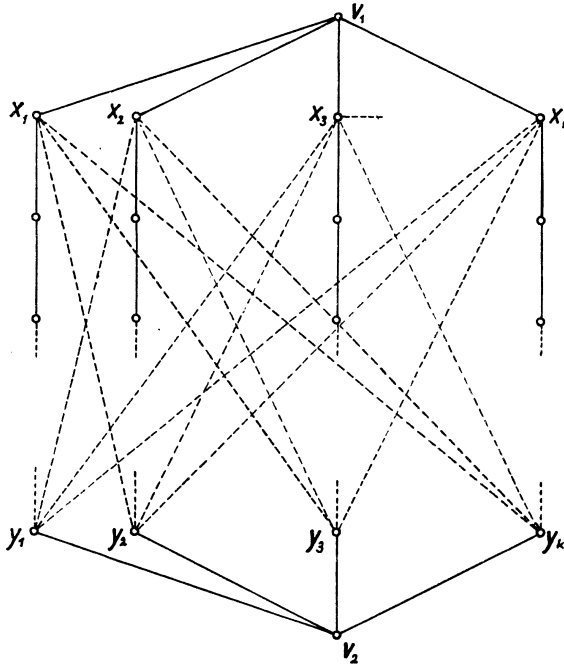

Fig. 9

**Proof.** (i) It follows from the condition b) that  $\chi$  assigns to any rib at least one number odd number of times. The remaining assertions in (i) are trivial.

(ii)  $o(D_{n,k}, \chi) = n$  implies without loss of generality that on each rib of  $D_{n,k}$  all the numbers  $1, 2, \dots, n$  occur. Since  $k > n$ , there are at least two edges, both of them incident with the same pole, which are assigned the same number  $j$  ( $1 \leq j \leq n$ ). This contradiction proves (ii).

(iii) follows from the fact that any number occurring on any rib odd number of times, occurs necessarily on each rib odd number of times.

Our main task in this paragraph is to construct bipartite graphs of arbitrarily large girth not allowing a C-valuation. We shall perform it by a suitable insertion of diamonds  $D_{n,k}$  into each other. Let us define a  $r$ -th iteration  $D_{n,k}^{(r)}$  of the diamond  $D_{n,k}$  by the following inductive definition:

(i)  $D_{n,k}^{(1)}$  is identical with  $D_{n,k}$ . The bearing diamond of  $D_{n,k}^{(1)}$  is  $D_{n,k}^{(1)}$  itself. The poles of  $D_{n,k}^{(1)}$  are called *poles of  $D_{n,k}^{(1)}$* .

(ii)  $D_{n,k}^{(r+1)}$  arises by an adjunction of  $k(k-1)$  copies of  $D_{n,k}^{(r)}$  to one specimen of  $D_{n,k}^{(r)}$ . This  $D_{n,k}^{(r+1)}$  is called *the bearing diamond of  $D_{n,k}^{(r+1)}$* , each copy of  $D_{n,k}^{(r)}$  which is added to the bearing diamond is a *descendant of  $D_{n,k}^{(r+1)}$* . The poles of the bearing diamond are called *the poles of  $D_{n,k}^{(r+1)}$* . Now  $D_{n,k}^{(r+1)}$  arises from its bearing diamond  $D_{n,k}^{(r)}$  in the following way: let  $v_1, v_2$  be the poles of  $D_{n,k}^{(r)}$ . Consider any two vertices  $x, y$  of  $D_{n,k}^{(r)}$  —  $x$  adjacent to  $v_1$ ,  $y$  adjacent to  $v_2$ ,  $x, y$  not belonging to the same rib — as new poles and “insert” between them one copy of the graph  $D_{n,k}^{(r)}$  (i.e. identify the poles of  $D_{n,k}^{(r)}$  with the vertices  $x, y$  of the bearing diamond  $D_{n,k}^{(r)}$ ).

Fig. 9 shows the graph  $D_{n,k}^{(r+1)}$  (simplified, of course, instead of each of its descendants only a dash line is drawn).

The iterations  $D_{n,k}^{(r)}$  of diamonds just defined are bipartite graphs of the girth  $2n$ . For a suitable  $r$  they do not allow a C-valuation as we shall see in the next theorem.

**Theorem.** *If  $k > n$  and  $r > \lfloor \frac{1}{2}(n-1) \rfloor$ , then  $D_{n,k}^{(r)}$  does not allow a C-valuation.*

When proving the theorem, we shall use an obvious notational convention: if  $\chi$  is a C-valuation of a graph  $G$ , then we denote by the same  $\chi$  the C-valuation induced on any subgraph  $G'$  of  $G$ . First of all, we shall prove the following.

**Lemma 2.** *Let  $k > n$  and let  $\chi$  be a C-valuation of the graph  $D_{n,k}^{(r)}$  whose bearing diamond is  $D$ . Then  $D_{n,k}^{(r)}$  has at least one descendant  $D_{n,k}^{(r-1)}$  with a bearing diamond  $D'$ , such that  $o(D', \chi) = o(D, \chi) + 2$ .*

*Proof.* Let us notice that for any C-valuation  $\chi$  of the diamond  $D = D_{n,k}$  (where  $k > n$ ) there is a pair of different ribs  $r_1, r_2$  in  $D$  with the following property: if we denote by  $x_1$  the vertex of the rib  $r_1$  adjacent to the pole  $v_1$  of  $D$  and analogously by  $y_2$  the vertex of  $r_2$  adjacent to  $v_2$ , then:

(i) an integer  $i$  assigned by  $\chi$  to the edge  $(x_1, v_1)$  occurs on the rib  $r_1$  (and therefore also on  $r_2$ ) even number of times;

(ii) an integer  $j$  assigned by  $\chi$  to the edge  $(y_2, v_2)$  occurs on the rib  $r_2$  (and therefore also on  $r_1$ ) even number of times;

(iii)  $i \neq j$ .

Therefore, we can write briefly

$$i \notin A(D, \chi), \quad j \notin A(D, \chi) \quad \text{and} \quad i \neq j.$$

Indeed,  $D$  consists of  $k$ , i.e. at least of  $n + 1$  ribs. According to (ii) of lemma 1  $\text{card}(A(D, \chi)) \leq n - 2$ ;  $\chi$  assigns the elements of  $A(D, \chi)$  to at most  $n - 2$  edges of  $D$ , incident with  $v_1$  (resp.  $v_2$ ), because two different edges incident with  $v_1$  (resp.  $v_2$ ) have a vertex in common and have to be assigned different numbers by  $\chi$ . There are  $k - n + 2$ , i.e. at least 3 ribs, to the edges of which incident with  $v_1$  the mapping  $\chi$  assigns numbers which do not belong to  $A(D, \chi)$ . Choose for  $r_1$  any of such ribs; the number  $i$  assigned by  $\chi$  to the edge  $(x_1, v_1)$  of that rib occurs on  $r_1$  even number of times. Similarly, one can see that there are  $k - n + 2$ , i.e. at least 3 ribs, to the edges of which incident with  $v_2$  the mapping  $\chi$  assigns numbers (obviously differing from each other), which do not belong to  $A(D, \chi)$ . Out of these at least 3 ribs, at most one is  $r_1$  and at most one is assigned (on its edge incident with  $v_2$ ) number  $i$ . Hence, there is at least one rib different from  $r_1$ , having a number  $j \neq i$  on its edge incident with  $v_2$ . Anyone of these ribs choose for  $r_2$ .

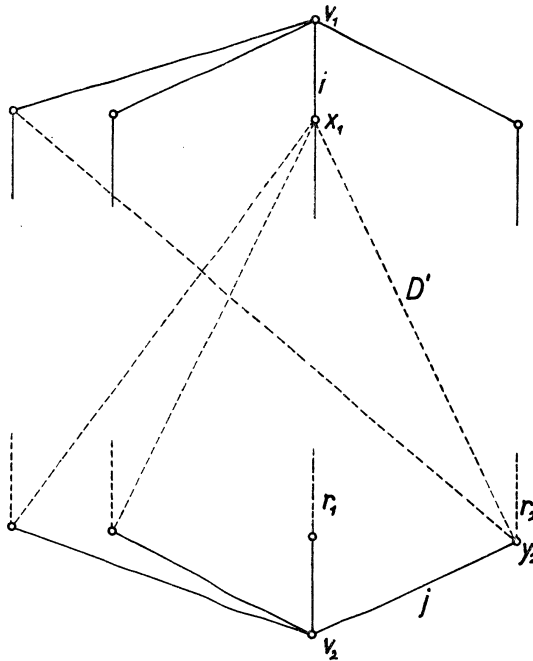

Fig. 10

Let  $\chi$  now be a C-valuation of  $D_{n,k}^{(r)}$ . There are two different ribs  $r_1, r_2$  with the properties (i)–(iii) in the bearing diamond  $D$  of  $D_{n,k}^{(r)}$ . Between the vertices  $x_1$  and  $y_2$  in  $D_{n,k}^{(r)}$  its descendant  $D_{n,k}^{(r-1)}$  with bearing diamond  $D'$  is inserted (cf. Fig. 10 where  $D'$  is drawn as a dash line between  $r_1$  and  $y_2$ ).

Let us determine  $o(D', \chi)$ .  $D'$  is a  $(n, k)$ -diamond with the poles  $x_1, y_2$ . In  $D_{n,k}^{(r)}$  there are two more paths of the length  $n$  from  $x_1$  to  $y_2$ . The first leads from  $x_1$  to  $v_1$  (along the edge  $(x_1, v_1)$ ) and then along the  $n - 1$  edges of the rib  $r_2$  to  $y_2$ , the second analogously from  $y_2$  to  $v_2$  and then along the rib  $r_1$  to  $x_1$ .  $D'$  becomes a  $(n, k + 2)$ -diamond  $D''$  by the addition of these two ribs. Either of the numbers  $i$  and  $j$  occurs on the added rib  $y_2, v_2, x_1$  (resp.  $x_1, v_1, y_2$ ) odd number of times. If  $l \in A(D, \chi)$ ,  $i \neq l \neq j$ , then  $l$  occurs on the added ribs the same number of times as on  $r_1$ , resp.  $r_2$ , it means odd number of times. Thus we have proved that

$$o(D'', \chi) = o(D, \chi) + 2.$$

According to (iii) of lemma 1 we have

$$o(D'', \chi) = o(D', \chi)$$

and therefore

$$o(D', \chi) = o(D, \chi) + 2$$

which accomplishes the proof of lemma 2.

**Proof of Theorem.** Suppose  $k > n, r > [\frac{1}{2}(n - 1)]$ , let  $\chi$  be a C-valuation of the graph  $D_{n,k}^{(r)}$ . Using lemma 2 several times, we find in  $D_{n,k}^{(r)}$  a sequence of its partial subgraphs (which are the iterations of diamonds)

$$D_{n,k}^{(r)}, D_{n,k}^{(r-1)}, \dots, D_{n,k}^{(1)}$$

such that  $D_{n,k}^{(i-1)}$  is a descendant of  $D_{n,k}^{(i)}$  ( $i = 2, \dots, r$ ) and if we denote their bearing diamonds accordingly

$$D^{(r)}, D^{(r-1)}, \dots, D^{(1)},$$

it follows that

$$o(D^{(i-1)}, \chi) = o(D^{(i)}, \chi) + 2, \quad i = 2, \dots, r.$$

Thus, we have

$$(*) \quad o(D^{(1)}, \chi) = o(D^{(r)}, \chi) + 2(r - 1).$$

For any  $(n, k)$ -diamond  $D_{n,k}$  (and therefore also for  $D^{(1)}$  and  $D^{(r)}$ ) we have from lemma 1

$$(**) \quad \varepsilon_n \leq o(D_{n,k}, \chi) \leq n - 2$$

where  $\varepsilon_n = 1$  (resp. 2) if  $n$  is odd (resp. even).

(\*) and (\*\*) imply

$$n - 2 \geq o(D^{(1)}, \chi) \geq \varepsilon_n + 2(r - 1) > n - 2$$

which is a contradiction proving Theorem.

**Remark.** Though the Theorem has been proved assuming  $n \geq 3$ , it holds true also for  $n = 2$ .  $D_{2,k}^{(r)}$  for  $k > 2$  and  $r \geq 1$  contains a complete bipartite graph  $K_{2,3}$ .

## 5. CONCLUDING REMARKS

In this section we present some open problems connected with the existence of B-valuation. In example 3 (section 3) the concept of a critical graph not allowing a C-valuation was introduced. Such a graph  $G$  does not allow a C-valuation, however, for any edge  $e$ , the graph  $G - e$  does allow a C-valuation. The operation of deleting an edge does not obviously diminish the girth of a graph. The following proposition follows then easily from Theorem.

**Corollary.** *For any integer  $q$  there is a critical graph not allowing a C-valuation whose girth is at least  $2q$ .*

The statement is, unfortunately, only an existential one; we do not know the exact form of critical graphs not allowing a C-valuation, of the girth  $2q$  (we do not even know whether  $D_{n,n+1}^{((n-1)/2)+1}$  is critical). In this connection an interesting problem of listing all critical graphs with small number of vertices should be mentioned.

From the practical point of view the following question is very interesting (and probably rather difficult): given a graph  $G$  allowing a B-valuation, find the smallest  $n$  such that  $G$  allows a  $B_n$ -valuation. The question can be restated in an equivalent form: given a graph  $G$ , decide whether  $G$  is embeddable in a unit cube of a suitable dimension and if the answer is yes, find the smallest dimension. (The question seems to be quite non-trivial even for trees).

Further, we do not consider the necessary and sufficient conditions the graph must fulfil in order to allow a B-valuation (Propositions 1 and 2) as a satisfactory solution of the problem. We find it very useful to look for another necessary, sufficient or necessary and sufficient conditions.

Finally, we present a problem similar to that of B-valuation: It is possible to look for the mapping  $\varphi$  of the set of vertices of  $G = \langle V, E \rangle$  into the set of vectors  $\mathbf{B}^n$  such that

- (i)  $u \neq v \Rightarrow \varphi(u) \neq \varphi(v)$  and
- (ii)  $(u, v) \in E \Leftrightarrow \varphi(u), \varphi(v)$  differ in exactly one component.

Every mapping fulfilling (i) and (ii) is, of course, a B-valuation (the converse statement does not generally hold). The problem of a suitable characterization of graphs allowing valuations which have been just described remains open.

### References

- [1] Berge, C.: Théorie des Graphes et Ses Applications, DUNOD Paris, 1958.
- [2] Ore, O.: Theory of Graphs, American Mathematical Society Colloquium Publications, Vol. XXXVIII, Providence, Rhode Island, 1962.
- [3] Hlavíčka, J.: Race-free assignment in asynchronous switching circuits, Information Processing Machines No 13, 1967.

*Authors' address:* Praha 1, Žitná 25, ČSSR (Matematický ústav ČSAV v Praze).