

Przemysław Ignaciuk

Soft variable structure control in time-delay systems with saturating input

Kybernetika, Vol. 57 (2021), No. 2, 236–255

Persistent URL: <http://dml.cz/dmlcz/149037>

Terms of use:

© Institute of Information Theory and Automation AS CR, 2021

Institute of Mathematics of the Czech Academy of Sciences provides access to digitized documents strictly for personal use. Each copy of any part of this document must contain these *Terms of use*.



This document has been digitized, optimized for electronic delivery and stamped with digital signature within the project *DML-CZ: The Czech Digital Mathematics Library* <http://dml.cz>

SOFT VARIABLE STRUCTURE CONTROL IN TIME-DELAY SYSTEMS WITH SATURATING INPUT

PRZEMYSŁAW IGNACIUK

In order to achieve a short regulation cycle, time-optimal control has been considered in the past. However, the sensitivity to errors and uncertainties, and implementation difficulties in the practical systems, have incited other research directions to meet this objective. In this paper, soft Variable Structure Control (VSC) is analyzed from the perspective of linear time-delay systems with input constraint. The desired fast convergence under a smoothly varying control signal is obtained. The stability issues originating from the non-negligible delay are addressed explicitly by incorporating a dead-time compensator, applicable to both structurally stable and unstable plants. The properties of the obtained dynamic soft VSC system are demonstrated analytically and compared with the linear and saturating control structures.

Keywords: soft Variable Structure Control, nonlinear control, time-delay systems, delay compensation

Classification: 93B12, 93C10, 93B52, 93A14

1. INTRODUCTION

Faced by the limitations of static architectures, dynamic controllers with explicit adaptability characteristics can be used to respond to changeable operational conditions [37]. Moreover, a properly managed cooperation of two or more control structures in fulfilling the principal objective of stability may result in new, opportune properties even when the environmental setting does not require adjustment of the applied control scheme. As an example, one can consider two otherwise unstable systems that, when coordinated by a prudently selected switching strategy, besides ensuring convergence to equilibrium, provide the uncertainty resilience in thus formed Variable Structure Control (VSC) system [40]. Depending on the design requirements, the emphasis is placed on different aspects and eventual properties of the constructed control system [26].

When the robustness is a priority (with the quality of the generated control signal a secondary objective), a popular approach is to introduce a high-gain switching element and create a sliding-mode system. Even though physical limitations do not permit achieving the ideal sliding mode, a high degree of robustness can be achieved [9, 13, 26, 38]. However, one needs to take special precautions to avoid the detrimental impact of chattering (switching-induced high-rate fluctuations) that may result prohibitive in

the practical applications [21, 1], especially, in the presence of delay [36]. When a smooth control action is of primary importance, a different class of VSC systems may be considered – *soft* VSC systems [2]. By continuous adjustment of the control structure to the current system state, soft VSC allows one to achieve a high regulatory rate, approaching the ideal of the time-optimal controllers. Unlike sliding-mode control that relies on the infinitely fast switching between a finite number of control structures, soft VSC flexibly engages new structures from an infinite pool to attain fast convergence to equilibrium. The input signal varies smoothly within the range permitted by constraints, which is particularly well suited for mechanical systems where abrupt changes of the control input inflict unnecessary stress and wear of the constituent components [24].

2. RELATED WORK AND CONTRIBUTION

The concept of soft VSC and the initial designs are well documented in an excellent review paper [2]. Later works extended the fundamental ideas to saturating implicit VSC [22], systems with simultaneous amplitude and rate constrained inputs [19], singular [23, 25, 41], fractional-order [17], and sampled-data [14] systems. The robustness issues were also briefly addressed in [4] and [16]. However, all those works assume that the control action can be exerted on the plant immediately, i.e., without any latency or time lag in the control channel. Motivated by their importance in many application areas, e.g., networked structures [8, 12, 15, 27, 30], biological [39], mechanical [42], and energy [43] systems, inventory and process control [10, 11, 31, 35], remote regulation and sensing [6, 29, 44], in this paper, the possibility of using soft VSC in the systems with non-negligible delay is investigated. In order to overcome the potentially destabilizing effect of the delay in the feedback loop, a dead-time compensator is incorporated. The compensator, applicable to both stable and unstable plants, mitigates the effects of information transfer latency despite, nonlinear by nature, control structure adjustments. The fundamental properties of thus formed compensator-based soft VSC system are formally proved. The desired smoothness of the generated input signal and improved convergence rate over linear control are achieved. The theoretical content is illustrated by numerical experiments incorporating a benchmark, yet challenging for time-delay control, open-loop unstable object [32].

The paper is organized in the following way. The model of the considered class of systems and soft VSC fundamental concepts are introduced in Section 3. The design procedure of soft VSC for the systems with non-negligible input-output delay is presented in Section 4. That section covers the stability, convergence, and robustness issues, addressed with an explicit account of the input saturation constraint. The analysis concludes with practical tuning guidelines. The results of simulation experiments are discussed in Section 5. The paper summary and final remarks are provided in Section 6.

Notation. The set of real numbers is denoted by \mathbb{R} and positive reals by \mathbb{R}_+ . Vectors (lower case) and matrices (capital letters) are written in bold face. \mathbb{R}^n represents the space of n -dimensional real vectors, and $\mathbb{R}^{n \times m}$ the space of $n \times m$ real matrices. $[\cdot]^T$ denotes the transpose.

3. PRELIMINARIES

3.1. System model

Consider the system with delayed input

$$\dot{\mathbf{x}} = \mathbf{A}\mathbf{x}(t) + \mathbf{b}u(t - \tau), \quad (1)$$

where $\mathbf{x} \in \mathbb{R}^n$ is the state vector, $u \in \mathbb{R}$ is the control input, $\mathbf{A} \in \mathbb{R}^{n \times n}$ and $\mathbf{b} \in \mathbb{R}^n$ for $n \in \mathbb{N}_+$, t is a continuous variable denoting the evolution of time and $\tau \geq 0$ represents the delay. The pair (\mathbf{A}, \mathbf{b}) is assumed controllable. The initial state $\mathbf{x}_0 = \mathbf{x}(0)$ belongs to a bounded set \mathbf{X}_0 ,

$$\mathbf{x}_0 \in \mathbf{X}_0, \quad (2)$$

and the initial input

$$u(t) = \psi(t) \text{ for } t \in [-\tau, 0). \quad (3)$$

The control signal is supposed to obey the constraint

$$|u| \leq u_0, \quad u_0 > 0. \quad (4)$$

It is assumed that the control system is feasible, i. e., one can establish control satisfying (4) such that under initial input (3) any $\mathbf{x}_0 \in \mathbf{X}_0$ can be brought to zero despite the non-negligible time delay in the input channel. Equivalently, one may consider only a (nonempty) set of points \mathbf{X}_0 and initial inputs (3) for which control system (1)–(3) can be stabilized under constraint (4). Equations (1)–(4) represent a typical class of systems considered in the soft VSC designs [2], with the exception of the retarded argument. In a latter part of the paper, it will be discussed how the presence of delay influences the design choices for the dynamic soft VSC system and its closed-loop behavior.

3.2. Soft VSC - fundamental concepts

If a linear controller $u(t) = -\mathbf{g}^T \mathbf{x}(t)$ with a fixed gain $\mathbf{g} \in \mathbb{R}^n$ is used to steer system (1), the convergence rate to the origin decreases as $\|\mathbf{x}\|$, with $\|\cdot\|$ denoting the Euclidean norm, diminishes. The transient time can be reduced by using nonlinear control, ideally, time-optimal performance can be achieved. Unfortunately, despite significant effort in the past [5] and recent achievements [3, 18], a time-optimal control law is difficult to synthesize and implement. The time-optimal control system is also susceptible to uncertainty (even small numerical errors can render it unstable). Moreover, the requirement to shift the input signal instantaneously from one extremity of permitted interval to another, can exert excessive stress on the physical components of a practical system thus reducing the time of failure-free operation.

Soft VSC attempts to combine the benefits of a smooth input established by the linear controllers and fast convergence of the time-optimal ones by a continuous adjustment of the control structure (Figure 1). The idea is to change the dynamics of the fundamental (typically linear) controller through flexible operation of a nonlinear switching rule so that high regulatory rate is maintained throughout the whole control cycle of bringing \mathbf{x}_0 to zero. In the systems with input delay, however, the decisions taken by the controller, which may be situated in a remote location [29], do not influence directly the plant

behavior. Therefore, since the control structure adjustments can impact the system state only after certain time elapses, special considerations are needed to guarantee the stability and maintain the desired objectives of soft VSC, beyond those associated with sampling and information processing latency [14].

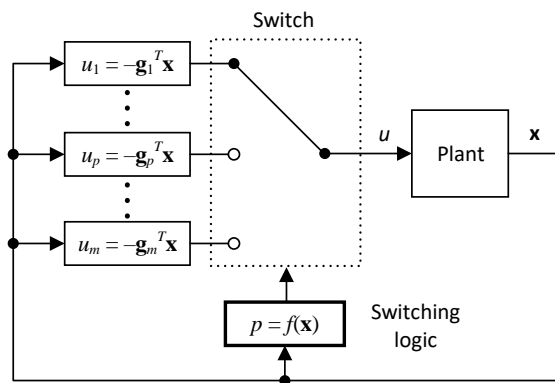

Fig. 1. Multi-controller VSC system.

4. DYNAMIC SOFT VSC FOR TIME-DELAY SYSTEMS

The section begins with introducing the fundamental control configuration incorporating a dead-time compensator. Next, the structure is extended to cover the saturation effects and analyzed from the perspective of stability, convergence, and robustness.

4.1. Soft VS controller

The following type of control is investigated:

$$u(t) = -\mathbf{g}^T(t)\mathbf{z}(t), \tag{5}$$

where $\mathbf{g}(t) \in \mathbb{R}^n$ is a time-varying control gain and $\mathbf{z}(t) \in \mathbb{R}^n$ reflects the system state.

Function $\mathbf{g}(t)$ is defined as

$$\mathbf{g}(t) = \mathbf{g}_1 + s(t)\mathbf{g}_2, \tag{6}$$

$\mathbf{g}_1, \mathbf{g}_2 \in \mathbb{R}^n$ are fixed gains and $s(t) \in \mathbb{R}$ is a time-dependent selection variable.

In order to achieve good response speed despite the presence of delay a compensator of the form

$$\mathbf{z}(t) = e^{\mathbf{A}\tau}\mathbf{x}(t) + \int_{t-\tau}^t e^{\mathbf{A}(t-\eta)}\mathbf{b}u(\eta) \, d\eta \tag{7}$$

is incorporated. It extends the classical Smith predictor to the case of structurally unstable plants [20].

Differentiating the terms on both sides of the equality sign in (7), one obtains

$$\dot{\mathbf{x}} = e^{\mathbf{A}\tau} \dot{\hat{\mathbf{x}}} + \mathbf{A} \int_{t-\tau}^t e^{\mathbf{A}(t-\eta)} \mathbf{b}u(\eta) d\eta + \mathbf{b}u(t) - e^{\mathbf{A}\tau} \mathbf{b}u(t-\tau). \quad (8)$$

With (1) and (7) applied, (8) reduces to

$$\dot{\mathbf{z}} = \mathbf{A}\mathbf{z}(t) + \mathbf{b}u(t). \quad (9)$$

Therefore, by using transformation (7), a delay-free system with respect to variable \mathbf{z} is obtained. Note that under finite-value control,

$$\mathbf{x}(t) = e^{-\mathbf{A}\tau} \mathbf{z}(t) - \int_{t-\tau}^t e^{\mathbf{A}(t-\tau-\eta)} \mathbf{b}u(\eta) d\eta \quad (10)$$

is finite for finite \mathbf{z} , so stability of (9) implies stability of (1) in the sense of Lyapunov. From the perspective of maintaining stability, the VSC design procedure that amounts to choosing gains $\mathbf{g}_1, \mathbf{g}_2$, and selection variable $s(t)$ can thus be performed equivalently in state space (9). However, the delay will impact the closed-loop characteristics (the degree of overshoots, the amplitude of oscillating waveforms, etc.) with respect to plant state \mathbf{x} , especially in the presence of uncertainty. Appropriate tuning guidelines will be provided.

The closed-loop system under control (5) becomes

$$\dot{\mathbf{z}} = [\mathbf{A} - \mathbf{b}\mathbf{g}_1^T - s(t)\mathbf{b}\mathbf{g}_2^T] \mathbf{z}(t) = [\mathbf{A}_1 - s(t)\mathbf{b}\mathbf{g}_2^T] \mathbf{z}(t). \quad (11)$$

Gain \mathbf{g}_1 is to be chosen so that matrix $\mathbf{A}_1 = \mathbf{A} - \mathbf{b}\mathbf{g}_1^T$ is Hurwitz. Moreover, the overall system is required to have a single (asymptotically) stable equilibrium point

$$\begin{bmatrix} \mathbf{z} \\ s \end{bmatrix} = \begin{bmatrix} \mathbf{0} \\ 0 \end{bmatrix}. \quad (12)$$

Soft VSC system with dead-time compensator (7) has been illustrated in Figure 2.

4.1.1. Choosing selection variable

A choice of selection variable $s(t)$ so that (12) is the unique stable equilibrium for system (9) is given in the following theorem.

Theorem 4.1. If there exist positive definite matrices $\mathbf{P}, \mathbf{Q} \in \mathbb{R}^{n \times n}$ satisfying

$$\mathbf{A}_1^T \mathbf{P} \mathbf{A}_1 - \mathbf{P} = -\mathbf{Q}, \quad (13)$$

for $\mathbf{A}_1 = \mathbf{A} - \mathbf{b}\mathbf{g}_1^T$, and the selection variable evolves as

$$\dot{s} = \frac{1}{q} [\mathbf{z}^T \mathbf{P} \mathbf{b} \mathbf{g}_2^T \mathbf{z} - s \cdot w(s, \mathbf{z})] \quad (14)$$

with $q \in \mathbb{R}_+$ and $w(s, \mathbf{z}) \in \mathbb{R}_+$, then (12) is the stable equilibrium of system (11).

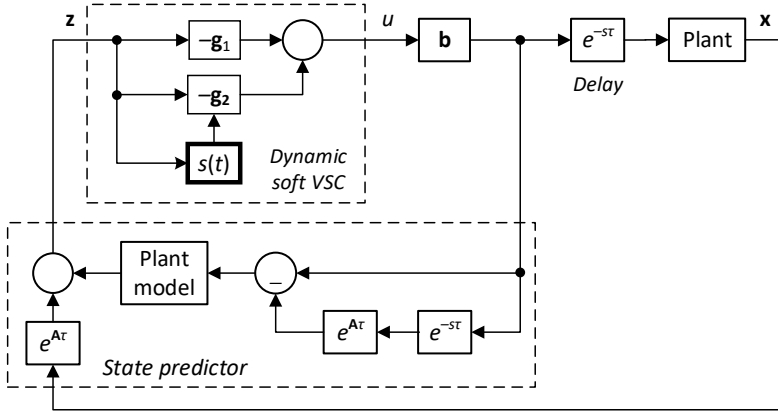

Fig. 2. Dynamic soft VSC with dead-time compensator for systems with input-output delay.

Proof. Let us consider the Lyapunov function candidate of the form

$$V(t) = \mathbf{z}^T(t)\mathbf{P}\mathbf{z}(t) + qs^2(t), \tag{15}$$

where $\mathbf{P} \in \mathbb{R}^{n \times n}$ is a positive definite matrix and q is a positive constant. Since \mathbf{P} is positive definite and $q > 0$, $V(t) > 0$ for $t > 0$ and $V(t) = 0$ at equilibrium (12). Therefore, in order for (15) to be a Lyapunov function for system (11), the derivative

$$\dot{V} = \dot{\mathbf{z}}^T\mathbf{P}\mathbf{z} + \mathbf{z}^T\mathbf{P}\dot{\mathbf{z}} + 2qs\dot{s} \tag{16}$$

along the state trajectory needs to be negative.

Using (11) in (16) yields

$$\begin{aligned} \dot{V} &= \mathbf{z}^T(\mathbf{A}_1^T\mathbf{P} + \mathbf{P}\mathbf{A}_1)\mathbf{z} - s\mathbf{z}^T(\mathbf{g}_2\mathbf{b}^T\mathbf{P} + \mathbf{P}\mathbf{b}\mathbf{g}_2^T)\mathbf{z} + 2qs\dot{s} \\ &= \mathbf{z}^T(\mathbf{A}_1^T\mathbf{P} + \mathbf{P}\mathbf{A}_1)\mathbf{z} + 2s(q\dot{s} - \mathbf{z}^T\mathbf{P}\mathbf{b}\mathbf{g}_2^T\mathbf{z}). \end{aligned} \tag{17}$$

Having substituted (14) for \dot{s} in (17), one arrives at

$$\dot{V} = \mathbf{z}^T(\mathbf{A}_1^T\mathbf{P} + \mathbf{P}\mathbf{A}_1)\mathbf{z} - 2s^2w(s, \mathbf{z}). \tag{18}$$

It follows from assumption (13) applied to (18) that

$$\dot{V} = -\mathbf{z}^T\mathbf{Q}\mathbf{z} - 2s^2w(s, \mathbf{z}). \tag{19}$$

Since \mathbf{Q} is positive definite and $w(s, \mathbf{z}) > 0$, $\dot{V} < 0$. Consequently, $V(t)$ given by (15) is a Lyapunov function for system (11), and the system is stable. \square

Remark 1. Note that for a Hurwitz matrix \mathbf{A}_1 , whose eigenvalues can always be placed in the open left-half plane by selecting a suitable gain vector \mathbf{g}_1 since the pair (\mathbf{A}, \mathbf{b}) is controllable, one can find a positive definite solution of Lyapunov equation (13) for arbitrary positive-definite \mathbf{Q} . On the other hand, any choice of function $w(s, \mathbf{z}) > 0$ makes $V(t)$ a Lyapunov function for system (11). In the next section, a procedure for selecting $w(s, \mathbf{z})$ for $u(t)$ obeying the constraint $|u| \leq u_0$ will be presented.

4.1.2. Design considerations for saturating input

Selection variable $s(t)$ needs to be chosen in such a way that control constraint (4) is satisfied at all time instants t . Directly from (5) and (6), condition (4) is met whenever

$$-u_0 \leq -[\mathbf{g}_1 + s(t)\mathbf{g}_2]^T \mathbf{z} \leq u_0, \quad (20)$$

which can be rewritten as the pair of inequalities:

$$\begin{aligned} \frac{-u_0 - \mathbf{g}_1^T \mathbf{z}}{\mathbf{g}_2^T \mathbf{z}} \leq s(t) \leq \frac{u_0 - \mathbf{g}_1^T \mathbf{z}}{\mathbf{g}_2^T \mathbf{z}} & \text{ for } \mathbf{g}_2^T \mathbf{z} > 0, \\ \frac{u_0 - \mathbf{g}_1^T \mathbf{z}}{\mathbf{g}_2^T \mathbf{z}} \leq s(t) \leq \frac{-u_0 - \mathbf{g}_1^T \mathbf{z}}{\mathbf{g}_2^T \mathbf{z}} & \text{ for } \mathbf{g}_2^T \mathbf{z} < 0. \end{aligned} \quad (21)$$

When \mathbf{z} approaches the equilibrium, the bounds expressed by (21) extend to infinity. Therefore, s needs to be further constrained as

$$|s| \leq s_0, \quad s_0 > 0. \quad (22)$$

Combining (21) and (22), one arrives at

$$s_L(\mathbf{z}) \leq s(t) \leq s_U(\mathbf{z}), \quad (23)$$

where

$$s_L(\mathbf{z}) = \begin{cases} \frac{u_0 - \mathbf{g}_1^T \mathbf{z}}{\mathbf{g}_2^T \mathbf{z}}, & \text{if } \mathbf{g}_2^T \mathbf{z} \leq \frac{-u_0 + \mathbf{g}_1^T \mathbf{z}}{s_0}, \\ -s_0, & \text{if } \frac{-u_0 + \mathbf{g}_1^T \mathbf{z}}{s_0} < \mathbf{g}_2^T \mathbf{z} < \frac{u_0 + \mathbf{g}_1^T \mathbf{z}}{s_0}, \\ \frac{-u_0 - \mathbf{g}_1^T \mathbf{z}}{\mathbf{g}_2^T \mathbf{z}}, & \text{if } \mathbf{g}_2^T \mathbf{z} \geq \frac{u_0 + \mathbf{g}_1^T \mathbf{z}}{s_0}, \end{cases} \quad (24)$$

and

$$s_U(\mathbf{z}) = \begin{cases} \frac{-u_0 - \mathbf{g}_1^T \mathbf{z}}{\mathbf{g}_2^T \mathbf{z}}, & \text{if } \mathbf{g}_2^T \mathbf{z} \leq \frac{-u_0 - \mathbf{g}_1^T \mathbf{z}}{s_0}, \\ s_0, & \text{if } \frac{-u_0 - \mathbf{g}_1^T \mathbf{z}}{s_0} < \mathbf{g}_2^T \mathbf{z} < \frac{u_0 - \mathbf{g}_1^T \mathbf{z}}{s_0}, \\ \frac{u_0 - \mathbf{g}_1^T \mathbf{z}}{\mathbf{g}_2^T \mathbf{z}}, & \text{if } \mathbf{g}_2^T \mathbf{z} \geq \frac{u_0 - \mathbf{g}_1^T \mathbf{z}}{s_0}. \end{cases} \quad (25)$$

Theorem 4.2. If there exist positive definite matrices \mathbf{P} and \mathbf{Q} satisfying (13), then selection strategy (14) with function $w(s, \mathbf{z})$ chosen as

$$w(s, \mathbf{z}) = \begin{cases} \mu \left(1 - \frac{s_L(\mathbf{z})}{s}\right) + \mu_0 \frac{s_L(\mathbf{z})}{s}, & \text{if } s \leq s_L(\mathbf{z}), \\ \mu_0, & \text{if } s_L(\mathbf{z}) < s < s_U(\mathbf{z}), \\ \mu \left(1 - \frac{s_U(\mathbf{z})}{s}\right) + \mu_0 \frac{s_U(\mathbf{z})}{s}, & \text{if } s \geq s_U(\mathbf{z}), \end{cases} \quad (26)$$

with $\mu > 1$, $0 < \mu_0 < 1$, $s_L(\mathbf{z})$ and $s_U(\mathbf{z})$ given by (24) and (25), respectively, ensures closed-loop stability of system (11) under the input restricted by (4) for the feasible set of initial conditions (2) and (3).

Proof. First note that for $s_0 > 0$, $s_L < 0$ and $s_U > 0$. Consequently, choosing $\mu > 1$ and $0 < \mu_0 < 1$ in (26), yields $w > 0$. The conditions specified in Theorem 4.1 are thus satisfied and system (11) is stable. It remains to be shown that w given by (26) does result in $|u| \leq u_0$.

It follows from (20)–(22) that inequalities (23) imply $|u| \leq u_0$. On the other hand, for s satisfying (23), $w = \mu_0 > 0$, and according to (14), it opposes the change of s . Since only those initial conditions that yield a feasible control system realization are considered, s evolving according to (14) does not fall outside the range $s_L(\mathbf{y}) \leq s(t) \leq s_U(\mathbf{y})$ for any $t \geq 0$. □

Remark 2. Expression (26) represents an anti-windup mechanism for saturating s that changes according to (14). The selection variable is effectively constrained to interval (23) and, as a consequence, the control input $|u| \leq u_0$. The choice of slopes μ_0 and μ (depicted in Figure 3) is discussed in Section 4.4.

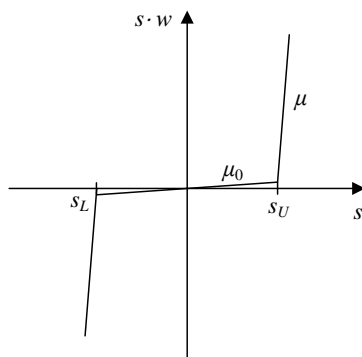

Fig. 3. Saturation function.

4.2. Convergence analysis

For the purpose of exposition, assume the initial plant state $\mathbf{x}_0 \neq 0$ and the initial input $\psi \equiv 0$, which yields $\mathbf{z}(0) = \mathbf{e}^{\mathbf{A}\tau} \mathbf{x}_0 \neq 0$. The state is to be driven to zero. For the selection variable $s(0) \approx 0$ one has $s(0)w(0) \approx 0$ and $|s|$ increasing according to (14) as

$$\dot{s} \approx q^{-1} \mathbf{z}^T \mathbf{P} \mathbf{b} \mathbf{g}_2^T \mathbf{z}. \tag{27}$$

Since $w > 0$, a growing value of s results in faster decrease of Lyapunov function V (relation (19)), and thus faster system convergence to equilibrium (12) than if a linear controller were used (with $s \equiv 0$).

On the other hand, as \mathbf{z} approaches zero, $\dot{s} \approx -sw/q$. Then, since $q, w > 0$, the selection variable will vanish with time, leaving the system predominantly under the influence of controller \mathbf{g}_1 which by design ensures asymptotic convergence. As $\mathbf{z} \rightarrow 0$, so does $u = -\mathbf{g}_1^T \mathbf{z}$, and consequently $\mathbf{x} \rightarrow 0$ (relation (10)).

4.3. Robustness issues

Consider the closed-loop system

$$\dot{\mathbf{y}} = [\mathbf{A} + \Delta\mathbf{A} - \mathbf{b}\mathbf{g}_1^T - s(t)\mathbf{b}\mathbf{g}_2^T]\mathbf{z}(t) = [\tilde{\mathbf{A}}_1 - s(t)\mathbf{b}\mathbf{g}_2^T]\mathbf{z}(t), \quad (28)$$

where $\Delta\mathbf{A}$ is an unknown matrix representing the cumulative effect of system uncertainty.

Lemma 4.3. Define $\mathbf{Z} = \mathbf{Z}^T > 0$ and its square root $\mathbf{Z} = \mathbf{Z}^{1/2}(\mathbf{Z}^{1/2})^T$. Then for any scalar $\alpha > 0$ and matrix \mathbf{X} of appropriate dimensions

$$\alpha^{-2}\mathbf{Z} + \alpha^2\mathbf{X}^T\mathbf{Z}^{-1}\mathbf{X} \geq \mathbf{X} + \mathbf{X}^T. \quad (29)$$

Proof. Since \mathbf{Z} is positive definite, its inverse \mathbf{Z}^{-1} does exist. On the other hand, for any real matrix \mathbf{M} one has $\mathbf{M}\mathbf{M}^T \geq 0$. In particular, for $\mathbf{M} = \alpha^{-1}\mathbf{Z}^{1/2} - \alpha\mathbf{X}^T\mathbf{Z}^{-1/2}$ one has

$$\begin{aligned} & (\alpha^{-1}\mathbf{Z}^{1/2} - \alpha\mathbf{X}^T\mathbf{Z}^{-1/2}) (\alpha^{-1}\mathbf{Z}^{1/2} - \alpha\mathbf{X}^T\mathbf{Z}^{-1/2})^T \\ &= (\alpha^{-1}\mathbf{Z}^{1/2} - \alpha\mathbf{X}^T\mathbf{Z}^{-1/2}) \left(\alpha^{-1} (\mathbf{Z}^{1/2})^T - \alpha (\mathbf{Z}^{-1/2})^T \mathbf{X} \right) \\ &= \alpha^{-2}\mathbf{Z} + \alpha^2\mathbf{X}^T\mathbf{Z}^{-1}\mathbf{X} - \mathbf{X} - \mathbf{X}^T \geq 0. \end{aligned} \quad (30)$$

After the term rearrangement in (30), inequality (29) is obtained. □

Using Lemma 4.3, a condition allowing system (28) to preserve the stability under perturbation $\Delta\mathbf{A}$ will be specified.

Theorem 4.4. If there exist positive definite matrices \mathbf{P} and \mathbf{Q} satisfying (13), then taking selection strategy (14) with function $w(s, \mathbf{z})$ given by (26) ensures closed-loop stability of system (28) if

$$(1 - \alpha^{-2})\mathbf{Q} > \alpha^2\Delta\mathbf{A}^T\mathbf{P}\mathbf{Q}^{-1}\mathbf{P}\Delta\mathbf{A}. \quad (31)$$

Proof. Consider Lyapunov function candidate (15). In uncertain system (28), $V = 0$ at equilibrium and $V > 0$ for $t > 0$. Let us investigate the value of \dot{V} . Substituting (28) into (16), yields

$$\dot{V} = \mathbf{z}^T (\tilde{\mathbf{A}}_1^T \mathbf{P} + \mathbf{P} \tilde{\mathbf{A}}_1) \mathbf{z} - 2s^2 w(p, \mathbf{z}). \quad (32)$$

Since $w(s, \mathbf{z}) > 0$, \dot{V} will be negative if

$$\tilde{\mathbf{A}}_1^T \mathbf{P} + \mathbf{P} \tilde{\mathbf{A}}_1 < 0. \quad (33)$$

On the other hand, equation (13) may be rewritten as

$$(\mathbf{A}_1 + \Delta \mathbf{A})^T \mathbf{P} + \mathbf{P}(\mathbf{A}_1 + \Delta \mathbf{A}) = -(\mathbf{Q} - \Delta \mathbf{A}^T \mathbf{P} - \mathbf{P} \Delta \mathbf{A}). \quad (34)$$

Thus $\tilde{\mathbf{A}}_1 = \mathbf{A}_1 + \Delta \mathbf{A}$ will remain an asymptotically stable matrix satisfying (33) if

$$\tilde{\mathbf{Q}} = \mathbf{Q} - \Delta \mathbf{A}^T \mathbf{P} - \mathbf{P} \Delta \mathbf{A} > 0. \quad (35)$$

Invoking Lemma 4.3 with $\mathbf{Z} = \mathbf{Q}$ and $\mathbf{X} = \mathbf{P} \Delta \mathbf{A}$, gives

$$\alpha^{-2} \mathbf{Q} + \alpha^2 \Delta \mathbf{A}^T \mathbf{P} \mathbf{Q}^{-1} \mathbf{P} \Delta \mathbf{A} \geq \Delta \mathbf{A}^T \mathbf{P} + \mathbf{P} \Delta \mathbf{A}. \quad (36)$$

Then, using assumption (31), one obtains

$$\tilde{\mathbf{Q}} \geq \mathbf{Q} - \alpha^{-2} \mathbf{Q} - \alpha^2 \Delta \mathbf{A}^T \mathbf{P} \mathbf{Q}^{-1} \mathbf{P} \Delta \mathbf{A} > 0, \quad (37)$$

which means that the system is stable. \square

4.4. Design summary and parameter selection

The designed dynamic soft VSC system employs compensator (7), to counteract the negative effects of delay, and primary plant controller (5), that needs to ensure the desired process dynamics according to the design specifications, e. g., settling time, maximum overshoot, etc. The operation of the primary controller depends on the gains \mathbf{g}_1 and \mathbf{g}_2 and selection strategy $s(t)$ defined by (14). The guidelines for choosing the controller parameters are presented below in the form of a step-by-step tuning procedure.

Step 1: Obtain the future state estimate using compensator (7). While the distributed delay term in (7) may pose implementation difficulties, in particular for unstable plants [28], dedicated numerical methods allow one to circumvent the internal stability issues [45]. In order to further alleviate the impact of modelling mismatch and perturbations besides considerations given in Section 3.5, alternative compensator structures [33] and uncertainty reduction methods [29] can be applied.

Step 2: Set gain \mathbf{g}_1 so that matrix $\mathbf{A}_1 = \mathbf{A} - \mathbf{b} \mathbf{g}_1^T$ is Hurwitz and good closed-loop performance, taking into account the quality requirements with respect to the dynamic response, is achieved. It is also necessary to ensure that $|\mathbf{g}_1^T \mathbf{z}(0)| \leq u_0$. In most engineering designs one may assume the initial input $\psi \equiv 0$, which translates the input constraint to $|\mathbf{g}_1^T e^{-\mathbf{A} \tau} \mathbf{x}_0| \leq u_0$.

Step 3: Set gain \mathbf{g}_2 . Plotting a root locus with variable s for $\dot{\mathbf{z}} = (\mathbf{A} - \mathbf{b} \mathbf{g}_1^T - s \mathbf{b} \mathbf{g}_2^T) \mathbf{z}$ provides good indication on the choice of \mathbf{g}_2 , as in a delay-free system. Usually, faster performance for the controller $(\mathbf{g}_1 + \mathbf{g}_2)$ than in the case of \mathbf{g}_1 acting alone is preferred.

Step 4: Choose positive-definite matrix \mathbf{Q} , e. g., an identity matrix, and determine \mathbf{P} as the solution to Lyapunov equation (13).

Step 5: Adjust the parameters of the selection variable: s_0 , μ , μ_0 , and q . s_0 should be chosen large (its sole purpose is to limit unchecked growth of s). Parameters μ and μ_0 govern the behavior of anti-windup scheme (26): μ should be chosen large (steep slope) for good efficiency near the saturation and μ_0 small so that parasitic dynamics are not injected into the linear region. Parameter q influences the decay rate of V . Usually, a large positive value yields good performance, though running simulations for various pairs (s, w) would point out a suitable setting.

5. NUMERICAL STUDY

The properties of the developed soft VSC are illustrated in a series of tests conducted for a benchmark – inverted pendulum-on-a-cart system (Figure 4) – to be controlled with non-zero input-output delay. With the parameters: mass of the cart $M = 0.768$ [kg], mass of the pole $m = 0.064$ [kg], moment of inertia around the center of gravity 0.002 [kg·m²], and distance between the pole gravity center and the shaft $l/2 = 0.2$ [m], the linearized (open-loop unstable) plant dynamics can be represented as the 4th-order system:

$$\dot{\mathbf{x}} = \begin{bmatrix} 0 & 1 & 0 & 0 \\ 0 & 0 & 0.29 & 0 \\ 0 & 0 & 0 & 1 \\ 0 & 0 & 28 & 0 \end{bmatrix} \mathbf{x}(t) + \begin{bmatrix} 0 \\ 1.17 \\ 0 \\ -3.43 \end{bmatrix} u_p(t). \quad (38)$$

The state is chosen as $\mathbf{x} = [y \ \dot{y} \ \theta \ \dot{\theta}]^T$ with y – the cart position and θ – the pole angular position. The input $u_p(t)$ is the driving force exerted on the cart. The initial state $\mathbf{x}(0) = [0 \ 0 \ \pi/6 \ 0]^T$ is to be brought to the origin by control u satisfying the constraint

$$|u| \leq u_0, u_0 = 15, \quad (39)$$

despite the delay of $\tau = 0.4$ s, i. e., $u_p(t) = u(t - 0.4)$. The initial input $\psi(t) \equiv 0$. In order to counteract the negative influence of delay (exceeding two times the plant dominant time constant 0.189 s), compensator (7) is applied. For preserving the numerical stability in the implementation of the distributed delay element, the technique advocated in [45] is employed.

In the tests, three control strategies are compared, all taking the benefit of compensator (7):

- linear controller $u(t) = -\mathbf{g}^T \mathbf{z}(t)$ with the gain set as $\mathbf{g} = [1.99; 2.78; 23.15; 4.28]$ (which corresponds to the closed-loop eigenvalues $\lambda_* = -2.86$);
- linear controller with saturation $u(t) = -\text{sat}[\mathbf{g}^T \mathbf{z}(t)]$ imposing directly constraint (39); the controller gain is tuned according to the guidelines given in [7] for fast transients as $\mathbf{g} = [12.19; 10.84; 47.75; 8.94]$;
- dynamic soft VSC (5) with selection variable (14): the gains $\mathbf{g}_1 = [1.99; 2.78; 23.15; 4.28]$ (closed-loop eigenvalues $\lambda_* = -2.86$) and $\mathbf{g}_2 = [94.05; 50.17; 138.6; 25.82]$

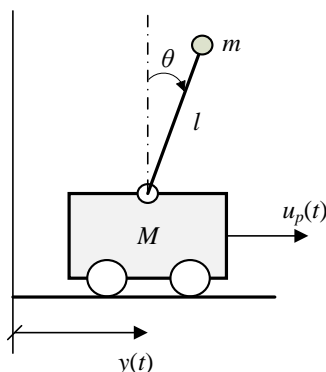

Fig. 4. Pendulum-on-a-cart system.

(closed-loop eigenvalues $\lambda_* = -7.5$), $s_0 = 100$, $q = 10^4$, $\mu = 10^6$, $\mu_0 = 10^{-2}$, $\mathbf{Q} = \text{diag}\{100, 1, 100, 1\}$.

Test 1 – Nominal system. The input signal generated by the controllers is depicted in Figure 5, the cart displacement in Figure 6, and the pole angular position in Figure 7. All three controllers make \mathbf{x}_0 vanish with time. As expected, the linear controller exhibits the slowest convergence (4.89 s). The compensator-based soft VSC shows improved convergence time (2.1 s) while avoiding clipping the input as is the case of saturating control. The soft nonlinearity allows one to retain a smooth input signal throughout the entire regulation cycle.

Test 2 – Uncertain delay. In the second series of simulations, the delay is estimated incorrectly by the controllers. The true value remains the same as in Test 1, whereas the one used to establish the compensator output either under-, or over-estimates the actual value. As determined through multiple simulation runs, all three controllers show sensitivity to delay mismatch. The least robust one occurs to be the saturating controller, which indicates a need to reduce its responsiveness. The performance of the linear and soft VSC schemes degrades gracefully, as shown in the plots in Figs. 8–11 for the case of 0.02 s (under-estimate) and 0.06 s (over-estimate) of the actual delay 0.04 s. A similar outcome is observed for the delay exhibiting small temporal variations around the estimate. In a practical implementation, the resilience to delay mismatches could be enhanced, e. g., by using information processing techniques [29].

Test 3 – Perturbed system. In the third series of simulations, the perturbation of the form

$$\mathbf{d}(t) = 0.3 \sin[t(\mathbf{x}(t) + \mathbf{x}(t - \tau))] \quad (40)$$

is introduced at the plant input (illustrated in Figure 12 for the linear system). Perturbation (40) affects all state variables.

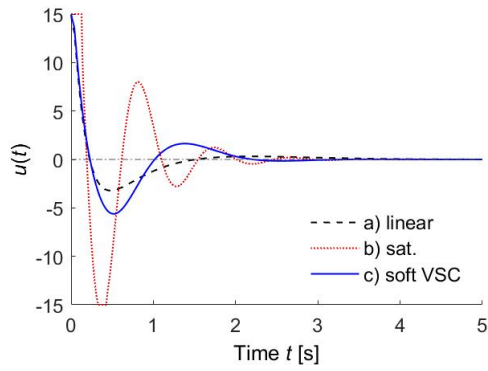
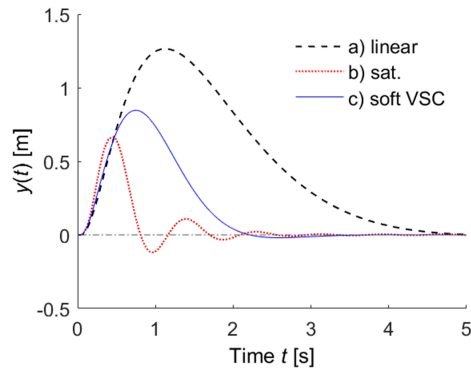
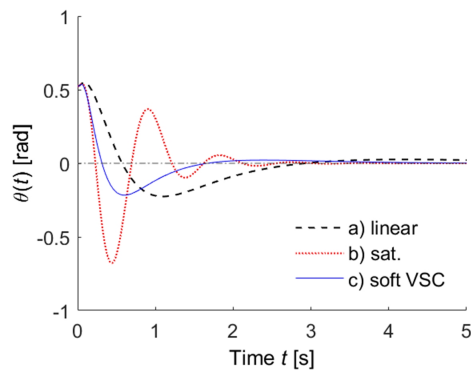
**Fig. 5.** Control input.**Fig. 6.** Cart position.**Fig. 7.** Pole angle.

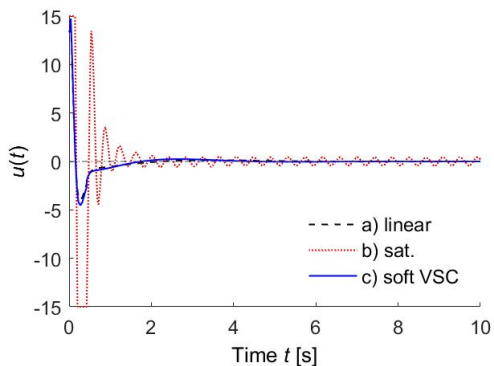

Fig. 8. Control input – actual delay 0.04 s, estimate 0.02 s.

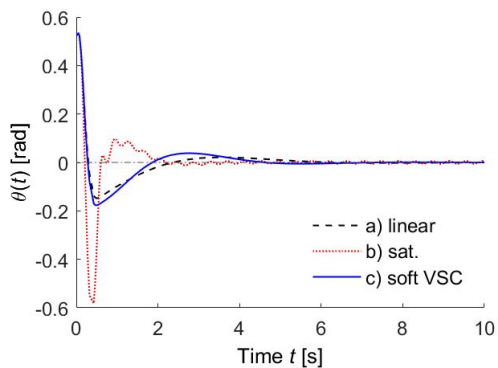

Fig. 9. Pole angle – actual delay 0.04 s, estimate 0.02 s.

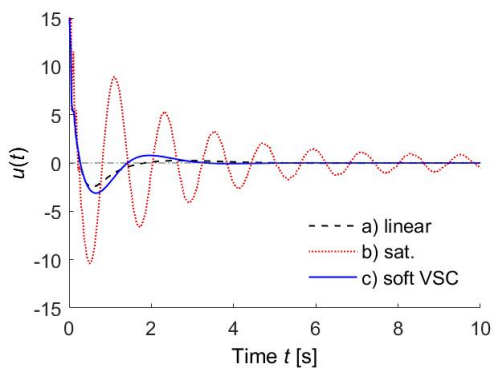

Fig. 10. Control input – actual delay 0.04 s, estimate 0.06 s.

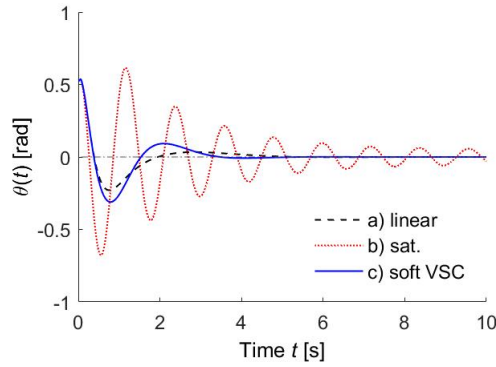

Fig. 11. Pole angle – actual delay 0.04 s, estimate 0.06 s.

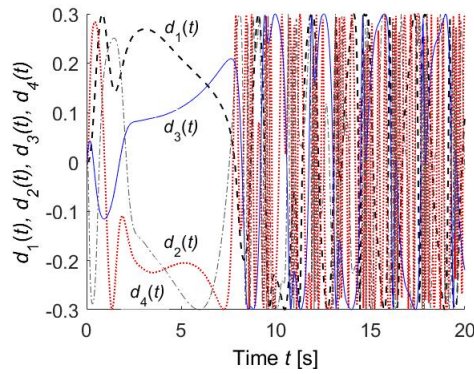

Fig. 12. Perturbation profile (linear system).

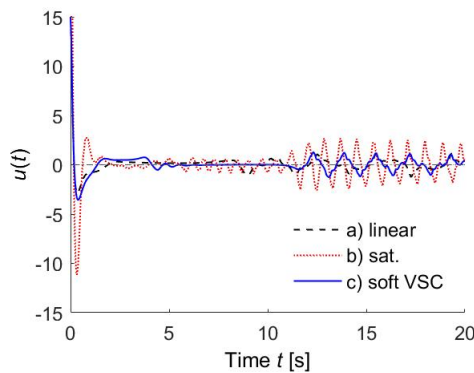

Fig. 13. Control input – perturbed system.

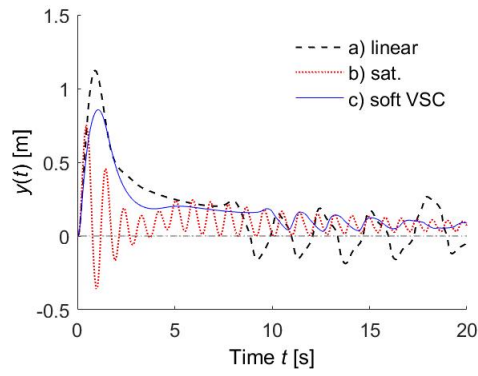

Fig. 14. Cart position – perturbed system.

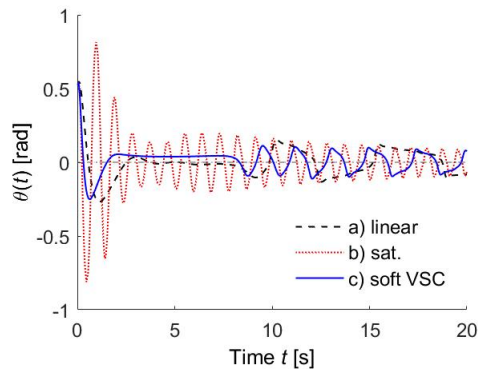

Fig. 15. Pole angle – perturbed system.

The input signal generated by the controllers is sketched in Figure 13, the cart displacement in Figure 14, and the pole angular position in Figure 15. Convergence to the origin is no longer guaranteed, yet bounded stability is achieved. The linear controller results the least sensitive one to the slowly-varying disturbance (for $t < 8$ s). The saturating controller enters into an oscillatory mode, which persists throughout the entire simulation interval. The soft VSC shows a similar degree of robustness as the linear controller with a smaller amplitude of oscillations, yet an increased frequency for the highly fluctuating disturbance (for $t > 8$ s). Nevertheless, the soft nonlinearity allows one to retain a smooth input signal at all times.

6. CONCLUSIONS

The paper elaborates on the perspectives of applying soft VSC in the settings with input delay, e. g., in remote regulation and steering applications. In order to tackle the issues related to non-negligible loop delay, a dead-time compensator has been incorporated into the control structure. Stability conditions have been formally established and robustness issues discussed. Moreover, guidelines for the control gain selection and dynamics adjustment have been given.

It has been shown that the proposed control structure is suitable for the application in the systems involving delayed input channels. It follows from the conducted tests that the designed nonlinear controller provides faster convergence to equilibrium than the linear strategy and improved robustness over saturating control, at the same time retaining a smooth input signal. The price to pay is a more complex structure to be implemented, involving two sub-controllers and a selection variable. However, indications for parameter selection within well-established tuning techniques have been provided.

The properties of the designed control system are demonstrated formally for the constant delay case. However, as shown in the simulation experiments, the soft VSC can maintain stability also under delay mismatch. It follows from the conducted tests that while each evaluated controller is sensitive to delay uncertainty, unlike the saturating control, the performance of the soft VSC scheme degrades gracefully. Still though, the formal analysis of the impact of delay variations, as well as modeling inaccuracies and structural uncertainty, need to be performed separately, e. g., by adopting the approach from [34].

(Received October 27, 2019)

REFERENCES

- [1] W. Abbasi, F. ur Rehman, and I. Shah: Smooth super twisting sliding mode based steering control for nonholonomic systems transformable into chained form. *Kybernetika* 54 (2018), 476–495. DOI:10.14736/kyb-2018-3-0476
- [2] J. Adamy and A. Flemming: Soft variable-structure controls: a survey. *Automatica* 40 (2004), 1821–1844. DOI:10.1016/j.automatica.2004.05.017
- [3] A. A. Agrachev and C. Biolo: Switching in time-optimal problem: the 3D case with 2D control. *J. Dyn. Control Syst.* 23 (2017), 577–595. DOI:10.1007/s10883-016-9342-7
- [4] M. S. Asadinia and T. Binazadeh: Robust soft variable structure control of perturbed singular systems with constrained input. *Control Cybernet.* 46 (2017), 345–360.

- [5] E. N. Chukwu: Stability and Time-Optimal Control of Hereditary Systems. Academic Press, Inc., San Diego 2001.
- [6] M. Cucuzzella and A. Ferrara: Practical second order sliding modes in single-loop networked control of nonlinear systems. *Automatica* *89* (2018), 235–240. DOI:10.1016/j.automatica.2017.11.034
- [7] P.-O. Gutman and P. Hagander: A new design of constrained controllers for linear systems. *IEEE Trans. Automat. Control* *AC-30* (1985), 22–33. DOI:10.1109/TAC.1985.1103785
- [8] J.-B. Hu, H. Wei, Y.-F. Feng, and X.-B. Yang: Synchronization of fractional chaotic complex networks with delays. *Kybernetika* *55* (2019), 203–215. DOI:10.14736/kyb-2019-1-0203
- [9] M. Idrees, S. Muhammad, and S. Ullah: Robust hierarchical sliding mode control with state-dependent switching gain for stabilization of rotary inverted pendulum. *Kybernetika* *55* (2019), 455–471. DOI:10.1007/978-3-658-27904-2_13
- [10] P. Ignaciuk: Dead-time compensation in continuous-review perishable inventory systems with multiple supply alternatives. *J. Proc. Control* *22* (2012), 915–924. DOI:10.1016/j.jprocont.2012.03.006
- [11] P. Ignaciuk: Nonlinear inventory control with discrete sliding modes in systems with uncertain delay. *IEEE Tran. Ind. Inform.* *10* (2014), 559–568. DOI:10.1109/TII.2013.2278476
- [12] P. Ignaciuk and A. Bartoszewicz: Flow control in connection-oriented networks – a time-varying sampling period system case study. *Kybernetika* *44* (2008), 336–359. DOI:10.1134/S1023193508040010
- [13] P. Ignaciuk and M. Karbowańczyk: Active queue management with discrete sliding modes in TCP networks. *Bull. Pol. Acad. Sci.-Te.* *62* (2014), 701–711.
- [14] P. Ignaciuk and M. Morawski: Quasi-soft variable structure control of discrete-time systems with input saturation. *IEEE Trans. Control Syst. Techn.* *27* (2019), 1244–1249. DOI:10.1109/TCST.2018.2797935
- [15] P. Ignaciuk and L. Wiczorek: Networked base-stock inventory control in complex distribution systems. *Math. Probl. Eng.* *2019* (2019), 1–14. DOI:10.1155/2019/3754367
- [16] B. Jasniewicz and J. Adamy: Fast robust control of linear systems subject to actuator saturation. In: *Proc. IFAC World Congr., Seoul 2008*, pp. 15179–15184.
- [17] S. Kamal and B. Bandyopadhyay: High performance regulator for fractional order systems: A soft variable structure control approach. *Asian J. Control* *17* (2015), 1342–1346. DOI:10.1002/asjc.1008
- [18] M. R. Kankashvar, F. Hashemzadeh, M. Baradarannia, and A. R. Ghiasi: State feedback time-optimal controller for linear systems with input delay. In: *2nd Int. Conf. Know. Eng. Innovat., Teheran 2015*, pp. 582–588.
- [19] K. Kefferpütz, B. Fischer, and J. Adamy: A nonlinear controller for input amplitude and rate constrained linear systems. *IEEE Trans. Automat. Control* *58* (2013), 2693–2697. DOI:10.1109/TAC.2013.2257967
- [20] M. Krstic and N. Bekiaris-Liberis: Compensation of infinite-dimensional input dynamics. *Ann. Rev. Control* *34* (2010), 233–244. DOI:10.1016/j.arcontrol.2010.09.002
- [21] H. Lee and V. I. Utkin: Chattering suppression methods in sliding mode control systems. *Ann. Rev. Control* *31* (2007), 179–188. DOI:10.1016/j.arcontrol.2007.08.001

- [22] H. Lens, J. Adamy, and D. Domont-Yankulova: A fast nonlinear control method for linear systems with input saturation. *Automatica* 47 (2011), 857–860. DOI:10.1016/j.automatica.2011.01.028
- [23] Y. Liu, C. Gao, B. Meng, and X. Cong: Dynamic soft variable structure control for singular systems. In: Proc. 30th Chinese Control Conf., Yantai 2011, pp. 2572–2577.
- [24] S. Liu, Y. Jiang, and P. Liu: Rejection of nonharmonic disturbances in nonlinear systems. *Kybernetika* 46 (2010), 785–798.
- [25] Y. Liu, Y. Kao, S. Gu, and H.R. Karimi: Soft variable structure controller design for singular systems. *J. Franklin Inst.* 352 (2015), 1613–1626. DOI:10.1016/j.jfranklin.2015.01.030
- [26] J. Liu and X. Wang: *Advanced Sliding Mode Control for Mechanical Systems. Design, Analysis and MATLAB Simulation.* Springer–Verlag, Berlin–Heidelberg 2012.
- [27] W.M. McEneaney and A. Pandey: An idempotent algorithm for a class of network-disruption games. *Kybernetika* 52 (2016), 666–695. DOI:10.14736/kyb-2016-5-0666
- [28] S. Mondié and W. Michiels: Finite spectrum assignment of unstable time-delay systems with a safe implementation. *IEEE Trans. Automat. Control* 48 (2003), 2207–2212. DOI:10.1109/TAC.2003.820147
- [29] M. Morawski and P. Ignaciuk: Reducing impact of network induced perturbations in remote control systems. *Control Eng. Prac.* 55 (2016), 127–138. DOI:10.1016/j.conengprac.2016.06.019
- [30] M. Morawski and P. Ignaciuk: Energy-efficient scheduler for MPTCP data transfer with independent and coupled channels. *Comput. Commun.* 132 (2018), 56–64. DOI:10.1016/j.comcom.2018.09.008
- [31] M.M. Naim, V. I. Spiegler, J. Wikner, and D.R. Towill: Identifying the causes of the bullwhip effect by exploiting control block diagram manipulation with analogical reasoning. *Eur. J. Oper. Res.* 263 (2017), 240–246.
- [32] Z. Neusser and M. Valasek: Control of the underactuated mechanical systems using natural motion. *Kybernetika* 48 (2012), 223–241.
- [33] J. E. Normey-Rico and E. F. Camacho: Dead-time compensators: a survey. *Control Eng. Prac.* 16 (2008), 407–428. DOI:10.1016/j.conengprac.2007.05.006
- [34] Ch. Peng, D. Yue, and Q.-L. Han: *Communication and Control for Networked Complex Systems.* Springer–Verlag, Berlin–Heidelberg 2015.
- [35] E. Petre, S. Tebbani, and D. Selisteanu: Robust-adaptive control strategies for a time delay bioelectrochemical process using interval observers. *Asian J. Control.* 17 (2015), 1767–1778. DOI:10.1002/asjc.997
- [36] J. Richard, F. Gouaisbaut, and W. Perruquetti: Sliding mode control in the presence of delay. *Kybernetika* 37 (2001), 277–294.
- [37] J.-J. Slotine and W. Li: *Applied Nonlinear Control.* Prentice Hall, Englewood Cliffs 1991.
- [38] O. J. Suarez, C. J. Vega, S. Elvira-Ceja, E. N. Sanchez, and D. I. Rodriguez: Sliding-mode pinning control of complex networks. *Kybernetika* 54 (2018), 1011–1032. DOI:10.14736/kyb-2018-5-1011
- [39] P. Sun, L. Zhang, and K. Zhang: Reconstructibility of boolean control networks with time delays in states. *Kybernetika* 54 (2018), 1091–1104. DOI:10.14736/kyb-2018-5-1091

- [40] V. I. Utkin: Variable structure systems with sliding modes. *IEEE Trans. Autom. Control* 22 (1977), 212–222. DOI:10.1109/TAC.1977.1101446
- [41] R. Xu, Y. Liu, C. Gao, and S. Wang: Soft variable structure control with differential equation for generalized systems. In: *Proc. 26th Chinese Control Dec. Conf., Changsha 2014*, pp. 530–535.
- [42] X. Yang, J. Yan, Ch. Hua, and X. Guan: Effects of quantization and saturation on performance in bilateral teleoperator. *Int. J. Robust Nonlin.* 30 (2020), 121–141. DOI:10.1002/rnc.4751
- [43] K.-Y. Yang, L.-L. Zhang, and J. Zhang: Stability analysis of a three-dimensional energy demand-supply system under delayed feedback control. *Kybernetika* 51 (2015), 1084–1100. [%hrefhttps://doi.org/DOI:](https://doi.org/DOI:)
- [44] D. Zhang, Y. Shen, and X. Xia: Globally uniformly ultimately bounded observer design for a class of nonlinear systems with sampled and delayed measurements. *Kybernetika* 52 (2016), 441–460. DOI:10.14736/kyb-2016-3-0441
- [45] Q.-Ch. Zhong: *Robust Control of Time-Delay Systems*. Springer–Verlag, London 2006.

*Przemysław Ignaciuk, Institute of Information Technology, Lodz University of Technology, 215 Wólczajska 215 St., 90-924 Łódź. Poland.
e-mail: przemyslaw.ignaciuk@p.lodz.pl*