

Emanuel Ontiveros-Robles; Patricia Melin; Oscar Castillo  
Comparative analysis of noise robustness of type 2 fuzzy logic controllers

*Kybernetika*, Vol. 54 (2018), No. 1, 175–201

Persistent URL: <http://dml.cz/dmlcz/147157>

## Terms of use:

© Institute of Information Theory and Automation AS CR, 2018

Institute of Mathematics of the Czech Academy of Sciences provides access to digitized documents strictly for personal use. Each copy of any part of this document must contain these *Terms of use*.



This document has been digitized, optimized for electronic delivery and stamped with digital signature within the project *DML-CZ: The Czech Digital Mathematics Library* <http://dml.cz>

# COMPARATIVE ANALYSIS OF NOISE ROBUSTNESS OF TYPE 2 FUZZY LOGIC CONTROLLERS

EMANUEL ONTIVEROS-ROBLES, PATRICIA MELIN AND OSCAR CASTILLO

Nowadays Fuzzy logic in control applications is a well-recognized alternative, and this is thanks to its inherent advantages as its robustness. However, the Type-2 Fuzzy Logic approach, allows managing uncertainty in the model. Type-2 Fuzzy Logic has recently shown to provide significant improvement in image processing applications, however it is also important to analyze its impact in controller performance. This paper is presenting a comparison in the robustness of Interval Type-2 and Generalized Type-2 Fuzzy Logic Controllers, in order to generate criteria to decide which type of controller is better in specific applications. The plants considered in the experimentation are two benchmark control plants and we report the Integral Squared Error (ISE), Integral Absolute Error (IAE) and Integral Time-weighted Absolute Error (ITAE) performance metrics, and also another important metric reported is the execution time. Based on the experimental results, Fuzzy Logic Controller selection criteria are proposed according to the performance and execution time requirements.

*Keywords:* interval Type-2 fuzzy logic, type-reduction, Type-2 fuzzy control, Type-2 fuzzy edge detection

*Classification:* 68T01, 93C42

## 1. INTRODUCTION

Control is one of the most well recognized applications of fuzzy logic [2, 3, 6], providing robustness [10, 12], free-model design [11], and better performance than classic alternatives, and this is mainly thanks to its non-linear modeling abilities. For this reason, Fuzzy Logic Controllers (FLC) are very useful in dealing with complex plants [16, 18, 21]. However, with the advances offered by fuzzy logic, and the emergence of type-2 fuzzy logic theory, and their implications expanding the options of FLC [7], allowing to design IT2 FLCs and GT2 FLCs, now it is important to find out what are the impact of these advances is, and justify the use of more complex controllers. The comparison between T1 and T2 FLCs is necessary, and some examples of papers where this comparison is realized, in [7] Hagrais presents the advantages of modeling the uncertainty in the FLCs and how T2 FLCs offers an improvement with respect to T1 FLCs, in [30] Wu provides an analysis of the differences between T1 and IT2 and in [27] Sanchez et al. provides a performance comparison for a particular complex applications. In this

case, the present paper aims at analyzing the performance of IT2 FLC and GT2 FLC to find the advantages and disadvantages of these controllers against the others, while focusing specially in the robustness, and based on this, we compare the performance of controllers in noise environments. The rest of the paper is organized as follows. Section 2 presents some basic concepts of fuzzy logic, Section 3 reports the experimental results with two benchmark plants and finally Section 4 presents the conclusions.

## 2. FUZZY LOGIC BACKGROUND

### 2.1. Type-1 fuzzy logic

In the literature [31], we can find the definition of a Fuzzy Set (FS) described by the membership function (MF), this first definition is now known as the Type-1 Fuzzy Set, and is expressed with the following Eq. (1).

$$A = \{(x, \mu_A(x) | x \in X)\}. \quad (1)$$

Where  $\mu_A(x)$  defines the membership degree of  $x$  to the set. Figure 1 shows the structure of a Mamdani Fuzzy Inference System (FIS). A fuzzy system [19] is composed of the fuzzifier, rules, inference and defuzzifier.

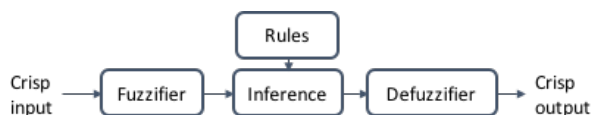

**Fig. 1.** Mamdani T1 FIS structure.

The fuzzifier realizes the conversion of crisp values to fuzzy values, the inference process evaluates the fuzzy rules based on the activation of the input fuzzy sets, and finally, the defuzzifier realizes the conversion of the resulted fuzzy values to output crisp values. Fig 2 shows a graphical representation of a Mamdani T1 FIS

For control applications, fuzzy systems have been well received because of their capability to control non linear plants without a mathematical model, and some examples of applications are [8, 9, 17, 20, 25, 28].

### 2.2. Interval Type-2 fuzzy logic

Based on the original concepts of Fuzzy Sets [15], Interval Type-2 Fuzzy Sets (IT2 FS) provides a mathematical approach of the uncertainty in its model, with the inclusion of a secondary domain that describes the uncertainty. Several advances in this approach have been realized in recent years. The mathematical expression of an IT2FS is as follows (Eq. 2).

$$\bar{A} = \{(x, u), 1 | \forall x \in X, \forall u \in J_x \subseteq [0, 1]\}. \quad (2)$$

Where  $x$  is the primary domain that represents the membership degree of the fuzzy set and  $u$  is the secondary domain related with the uncertainty and is always equal to 1.

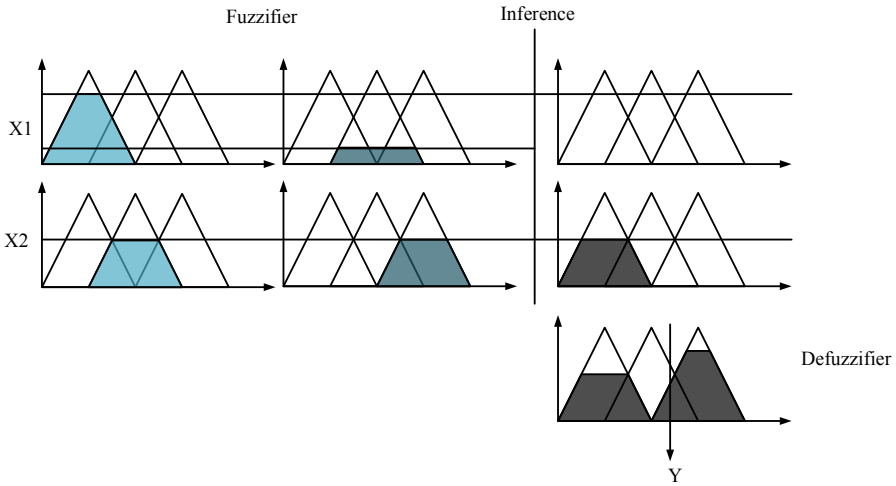

**Fig. 2.** Mamdani T1 FIS.

An IT2 MF can be defined based on two T1 MFs, and these are known as the upper MF and lower MF and the Footprint of Uncertainty (FOU) [23] that is in between both of them, and Figure 3 illustrates this representation.

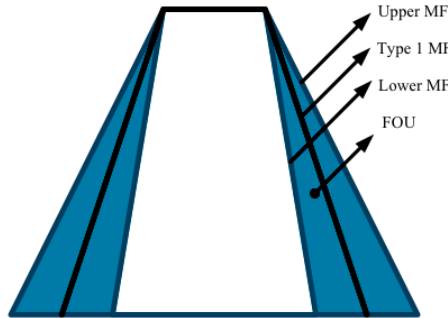

**Fig. 3.** IT2 MF.

In an IT2 FIS the inference is very similar to a T1 FIS, and the modus ponens of IT2 FISs is expressed by Eq. 3.

$$\begin{aligned}
 \mu_{\tilde{A}(x,u)} \sqcup \mu_{\tilde{B}(x,w)} &= \{(v, f_x(u) \otimes f_x(w)) \mid v \in u \vee w, u \in J_x^u \subseteq [0, 1], w \in J_x^w \subseteq [0, 1]\} \\
 \mu_{\tilde{A}(x,u)} \sqcap \mu_{\tilde{B}(x,w)} &= \{(v, f_x(u) \otimes f_x(w)) \mid v \in u \wedge w, u \in J_x^u \subseteq [0, 1], w \in J_x^w \subseteq [0, 1]\}.
 \end{aligned}
 \tag{3}$$

The T-Norm and S-Norm special operations also are extended to IT2 FS and are

Step	Left point	Right point
1	Sort $x_i$ by increasing order	Sort $x_i$ by increasing order
2	Initialize $w_i$ as: $w_i = \frac{\bar{w}_i + w_i}{2}$	Initialize $w_i$ as: $w_i = \frac{w_i + \bar{w}_i}{2}$
3	Compute $y = \frac{\sum_{i=1}^N x_i w_i}{\sum_{i=1}^N w_i}$	Compute $y = \frac{\sum_{i=1}^N x_i w_i}{\sum_{i=1}^N w_i}$
4	Find k where $x_k < y < x_{k+1}$	Find k where $x_k < y < x_{k+1}$
5	Set $w_i = \begin{cases} \bar{w}_i, & i \leq k \\ w_i, & i > k \end{cases}$	Set $w_i = \begin{cases} w_i, & i \leq k \\ \bar{w}_i, & i > k \end{cases}$
6	Compute $y = \frac{\sum_{i=1}^N x_i w_i}{\sum_{i=1}^N w_i}$	Compute $y = \frac{\sum_{i=1}^N x_i w_i}{\sum_{i=1}^N w_i}$
7	If then stop, set and , if not go to step 8	If then stop, set and , if not go to step 8
8	Set and go to step 3	Set and go to step 3

**Tab. 1.** Karnik–Mendel Algorithm.

called meet and join respectively, and these are expressed in Eq. 4.

$$\begin{aligned} \mu_{\tilde{A}(x,u)} \sqcup \mu_{\tilde{B}(x,w)} &= \{(v, f_x(u) \otimes f_x(w)) \mid v \in u \vee w, u \in J_x^u \subseteq [0, 1], w \in J_x^w \subseteq [0, 1]\} \\ \mu_{\tilde{A}(x,u)} \sqcap \mu_{\tilde{B}(x,w)} &= \{(v, f_x(u) \otimes f_x(w)) \mid v \in u \wedge w, u \in J_x^u \subseteq [0, 1], w \in J_x^w \subseteq [0, 1]\}. \end{aligned} \tag{4}$$

Where it can be observed that the outputs are computed as two T1 FISs with a new block of a Type-Reduction process [14].

This process has been studied widely by several researchers in order to reduce the computational cost and there exist many variations of type-reduction. The most used and the one that inspired all variations is the one that was originally proposed by Karnik and Mendel in [13] and is the called KM Type-Reduction. Table 1 describes the most used Type-Reduction method, which is called the KM reduction. On other hand, the structure of a FIS based on IT2 FL is illustrated in Figure 4.

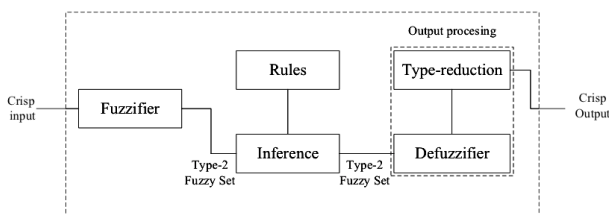

**Fig. 4.** Mamdani IT2 FIS.

The IT2 FLCs are also appreciated in control applications because they also provide a non-linear control, but in addition provide the uncertainty consideration in their model, and some examples of applications of IT2 FLCs are [27], [1, 5, 29].

**2.3. Generalized Type-2 fuzzy logic**

The mathematical expression of Generalized Type-2 Fuzzy Sets is similar to the IT2 FS expression, and it is because, IT2 FSs, are special cases of GT2 FSs (Eq. 5).

$$\tilde{A} = \{((x, u), \mu_{\tilde{A}}(x) | \forall x \in X, \forall u \in J_x^u \subseteq [0, 1])\}. \tag{5}$$

This is because in an IT2 FS the FOU is uniform and equal to 1; however, in GT2 FS the FOU has values between 0 and 1 and this is expressed in Eq. 6.

$$FOU(\tilde{A}) = \{(x, u) \in X \times [0, 1], \mu_{\tilde{A}}(x, u) > 0\}. \tag{6}$$

A graphical illustration of GT2 FS can be observed in Figure 5.

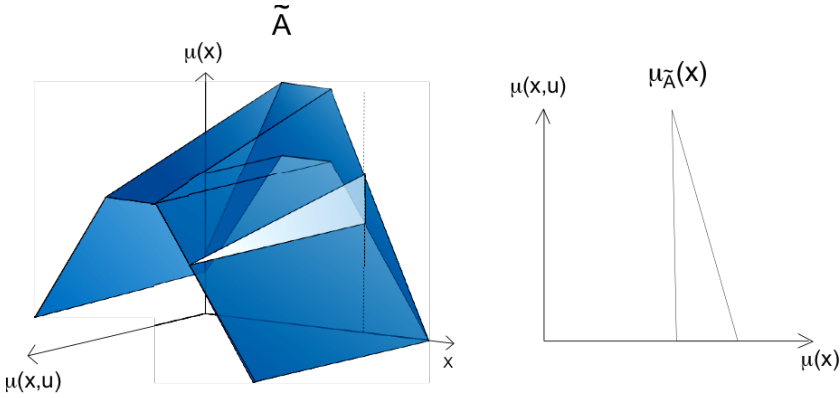

**Fig. 5.** GT2 FS representation.

Where is the primary domain that represents the membership degree of the fuzzy set and is the secondary domain related with the uncertainty, but in this case, is not always 1, and further it is defined as a secondary membership function of the uncertainty.

**2.4. α-planes representation**

This theoretical expression can be represented by the union of special cases of IT2 FS known as α-planes [24](Eq. 8), and each α-plane is equivalent to an IT2 FS (Eq. 7).

$$\tilde{A}_\alpha = \{((x, u), \alpha | \forall x \in X, \forall u \in J_x \subseteq [0, 1])\} \tag{7}$$

$$\tilde{A} = \cup \tilde{A}_\alpha. \tag{8}$$

Based on this, [22] proposes the system output to be calculated as follows (Eq. 9).

$$\tilde{Z} = \frac{\sum \alpha Z_\alpha}{\sum \alpha}. \tag{9}$$

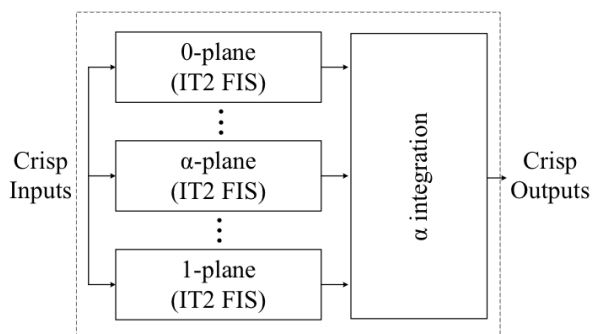

**Fig. 6.** GT2 FIS based on  $\alpha$ -planes.

A representation of GT2 FIS based on  $\alpha$ -planes is illustrated in Figure 6.

Considering this representation of a GT2 FIS we can observe the magnitude of the computational cost, because an IT2 FIS demands near double the cost than a T1 FIS, however a GT2 FIS demands significantly more computational cost depending the number of  $\alpha$ -planes considered. However, it is interesting to mention how the T1 FIS and the IT2 FIS are included as special cases of GT2 FIS, which provides a better model of vagueness and uncertainty achieving the representation of more complex inference systems, Figure 7 illustrates special cases of GT2 FS that describe the IT2 FS and the T1 FS.

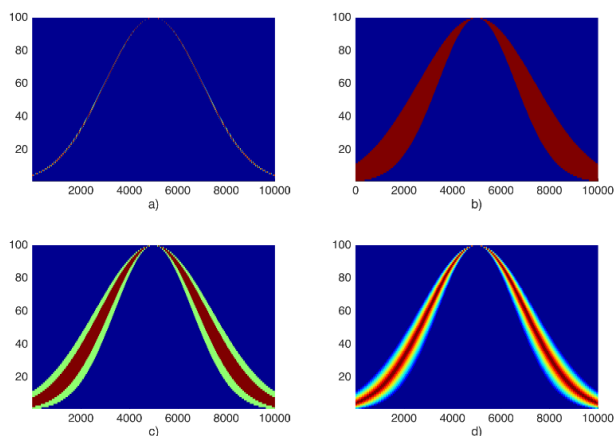

**Fig. 7.** a) GT2 FS with FOU near to 0 (equal to T1 FS), b) GT2 FS with uniform FOU (equal to IT2 FS), c) GT2 with 2 -planes, d) GT2 with 10 -planes.

## 2.5. Type 2 MFs representations

In the present work, the representation of the T2 MF is designed based on a T1 MF in order to compare the performance of the different controllers using the same structure for the fuzzy sets. We consider the trapezoidal membership function [31] as expressed in Eq. 10.

$$T1MF = \text{trapmf}(x, [a, b, c, d]). \quad (10)$$

Based on this T1 MF we propose the design of an IT2 MF as follows (Eq. 11).

$$IT2MF = \begin{cases} \text{trapmf}(x, [a - \frac{u}{2}, b, c, d + \frac{u}{2}]) \\ \text{trapmf}(x, [a + \frac{u}{2}, b, c, d - \frac{u}{2}]) \end{cases} \quad (11)$$

Where  $u$  is a proposed variable to change the FOU of the IT2MF, and the design considers the upper and lower membership functions. The graphical representation of Eq. 11 is illustrated in Figure 8.

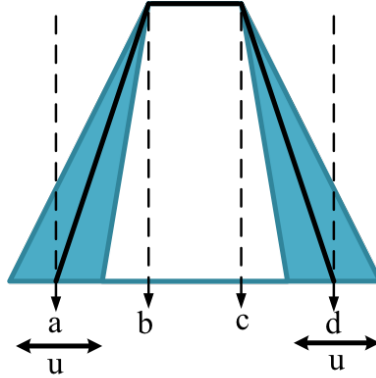

Fig. 8. IT2 Trapezoidal membership function.

As can be observed, this approach proposes to consider only symmetric MFs, in this study.

## 3. EXPERIMENTS

The aim of this section is to perform experiments in order to evaluate the robustness of T2 FLC, and the structure of this section is as follows. First, we introduce the plants and their T2 FLC, we propose nine different controllers by varying the FOU, having sixteen T2 FLCs considering eight IT2 FLCs plus eight GT2 FLC. The comparison of these controllers is presented by the evaluation of each plant with different levels of noise, reporting the SSE, ISE, IAE and ITAE performance metrics [4], and in this way, we compare the robustness of the controllers with the z-test. Figure 9 illustrates the basic structure of the experiments related with varying the noise.

We propose to use the Simulink block Uniform Random Number to introduce perturbations to the controller inputs, with a magnitude directly proportional to the input



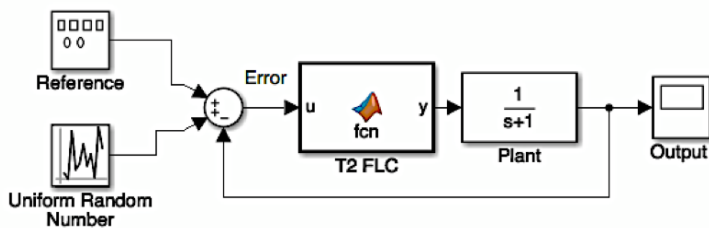

Fig. 9. Experiment setup.

Controller	a	b	c	d	e	f	g	h
u	1	2	3	5	8	15	20	25

Tab. 2. T2 FLCS varying FOU by parameter U.

signals, therefore the noise magnitude was represented between 0 to 1. The variation of the FOU is realized by changing the parameter  $u$ , and Table 2 summarizes the different controllers used in the experimentation.

### 3.1. Water level control plant

The water level control plant [2] (Figure 10) is commonly used to compare the performance of Fuzzy Logic Controllers (FLC), and the problem consists in achieving level control of a tank based on manipulating the valve. The FLC has two inputs (Level and

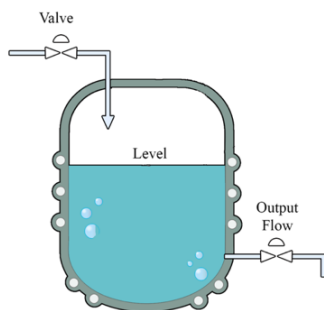

Fig. 10. Plant 1 graphical representation.

Rate) and one output (Valve). Table 3 summarizes the rules of the fuzzy controller. Based on the controllers defined in Table 2 for different FOU levels, Figure 11 illustrates the IT2 FLC fuzzy sets with different levels of FOU.

Level	Rate	Valve
Ok		No Change
Low		Open Fast
High		Close Fast
Ok	Positive	Close Slow
Ok	Negative	Open Slow

**Tab. 3.** Knowledge base.

u	Interval Type-2	General Type-2
0	2.9386	2.9303
0.01	2.941	2.9338
0.02	2.9439	2.9378
0.03	2.9469	2.9419
0.05	2.9531	2.9498
0.08	2.9628	2.9629
0.15	2.9617	2.9547
0.2	2.9965	2.9632
0.25	3.3003	3.2398

**Tab. 4.** ISE comparison summary.

Based on the rules established in Table 3, and the fuzzy sets shown in Figure 11, the control surfaces are illustrated in Figure 12.

By the same way of Figure 11, Figure 13 illustrates the fuzzy sets with different FOUs, however, in this case, for GT2 FLCs.

Figure 14 illustrates the GT2 FLCs control surfaces with different FOU levels.

It is interesting to observe how the control surfaces in GT2 FLC are very similar independent of the FOU, this can be explained because in GT2 FLC the  $\alpha$ -plane related with the core of the secondary membership function have a major impact in the controller response, and the other  $\alpha$ -planes contributes with nonlinearities that improve the GT2 FLC performance.

### 3.2. Performance by varying the FOU

In order to compare the robustness of the T2 FLCs, we realize multiple experiments with different noise levels and we are reporting the values of the three performance metrics. Table 4, reports the ISE results of over 2000 experiments with noise levels between 0 to 0.5.

Figure 15 illustrates the results reported in Table 4, where can be observed as the GT2 FLC show a reduction of the ISE with respect to the IT2 FLCs.

Table 5 reports the IAE results of over 2000 experiments with noise levels between 0 to 0.5.

Figure 16 illustrates the results reported in Table 5 and by the same way, shows a

u	Interval Type-2	General Type-2
0	1.9471	1.9451
0.01	1.9476	1.9458
0.02	1.9482	1.9466
0.03	1.9488	1.9473
0.05	1.95	1.9487
0.08	1.9521	1.9502
0.15	1.9551	1.9492
0.2	1.966	1.9543
0.25	2.0408	2.0229

**Tab. 5.** IAE comparison summary.

u	Interval Type-2	General Type-2
0	8.634	7.769
0.01	8.635	7.773
0.02	8.642	7.787
0.03	8.657	7.812
0.05	8.711	7.896
0.08	8.914	8.233
0.15	9.307	8.828
0.2	9.959	9.259
0.25	13.801	12.768

**Tab. 6.** ITAE comparison summary.

better performance for the GT2 FLCs with respect to IT2 FLCs

Table 6 reports the ITAE results of over 2000 experiments with noise levels between 0 to 0.5.

Figure 17 illustrates the results reported in Table 6 and also shows an improvement of the GT2 FLCs in the performance measured by the ITAE metric with respect to IT2 FLCs.

### 3.3. D.C. motor speed controller

The D.C. motor speed controller [26] is used as a common benchmark problem in many works, it has different versions but is a stable second order plant in which the goal is reducing the error in the speed reference.

The FLC works with two inputs (Error and Change of Error) and with one output (Change in voltage) and this output is integrated in an analogous form to a PID Controller. In the same way as in the first plant, we propose to use sixteen different plants, in order to compare the robustness of both type of controllers, IT2 FLCs and GT2 FLCs. Based on the controllers defined in Table 2 for different FOU levels, Figure 19 illustrates the IT2 FLC fuzzy sets with different levels of FOU

u	Interval Type-2	General Type-2
0	0.0655	0.0618
0.01	0.0743	0.0711
0.02	0.0741	0.0712
0.03	0.074	0.0714
0.05	0.0758	0.0737
0.08	0.0772	0.0759
0.15	0.0829	0.0821
0.2	0.0873	0.0864
0.25	0.0953	0.0941

**Tab. 7.** ISE comparison summary.

u	Interval Type-2	General Type-2
0	0.0433	0.0427
0.01	0.0526	0.052
0.02	0.0525	0.052
0.03	0.0525	0.052
0.05	0.054	0.0536
0.08	0.0552	0.0549
0.15	0.0592	0.0589
0.2	0.0621	0.0617
0.25	0.067	0.0664

**Tab. 8.** IAE comparison summary.

Based on the fuzzy sets shown in Figure 19, the IT2 FLCs control surfaces are illustrated in Figure 20.

Figure 21 illustrates the GT2 FLC fuzzy sets with different levels of FOU.

The GT2 FLCs control surfaces are illustrated in Figure 22.

It is interesting to observe how the control surfaces in the GT2 FLC are very similar independent the FOU, this can be explained because in GT2 FLC the a-plane related with the core of the secondary membership function have a major impact in the controller response, and the other a-planes contributes with nonlinearities that improve the GT2 FLC performance.

### 3.4. Performance by varying the FOU

Table 7 reports the ISE results of over 2000 experiments with noise levels between 0 to 0.5.

Figure 23 illustrates the results reported in Table 7 that shows a better performance of the GT2 FLCs with respect to IT2 FLCs based on the IAE metric.

Table 8 reports the ISE results of over 2000 experiments with noise levels between 0 to 0.5.

u	Interval Type-2	General Type-2
0	0.003	0.0025
0.01	0.0037	0.0032
0.02	0.0036	0.0032
0.03	0.0036	0.0032
0.05	0.0038	0.0034
0.08	0.0039	0.0037
0.15	0.0045	0.0044
0.2	0.005	0.0049
0.25	0.0061	0.0059

**Tab. 9.** ITAE comparison summary.

T1	IT2	GT2
0.6156	1.9075	$1.5725\alpha$

**Tab. 10.** Time Response Comparison.

Figure 24 illustrates the results reported in Table 8 that shows a similar, but better performance of GT2 FLCs with respect to IT2 FLCs based on the ISE metric.

Table 9 reports the ITAE results of over 2000 experiments with noise levels between 0 to 0.5. Figure 25 illustrates the results reported in Table 9 that shows a reduction of the ITAE metric for GT2 FLCs with respect to IT2 FLCs.

#### 4. CONCLUSIONS

As a conclusion, based on the realized experiments, the GT2 FLCs demonstrate better performance than IT2 FLCs in noisy environments. This is because the GT2 FLCs offer a better approach of uncertainty in their design, and this is reflected in the results. Remembering how the real world provides many noise sources, the GT2 FLC represents an attractive alternative to control high order plants without mathematical model and with many uncertainty sources. However, the advantages of GT2 FLCs with respect to IT2 FLCs are not enough to right now increase the implementation of GT2 FLCs in real applications, this is because the computational cost of GT2 FLCs is very high. Realizing a simple experiment, we can illustrate the computational cost comparison, and Table 10 reports the results of the simulation times; these results are the average of 30 experiments with 10000 fuzzy evaluations each experiment. The result of GT2 FLCs time response is a linear function dependent of  $\alpha$ , where  $\alpha$  represents the number of  $\alpha$ -planes in the GT2 FS representation, with a slope of 1.0725, and Figure 26 shows graphically these results.

As can be observed, the computational cost of GT2 FLCs is very high, and this represents an implementation problem. Based on the experiments and considering the application environment we propose in Table 11 some preliminary criteria to select a particular type of FLC in control applications. As future work we will consider evaluating the FLC by varying the MFs of the input-outputs fuzzy sets. In addition, include

different metrics such as stability metrics and consider more complex problems.

## ACKNOWLEDGEMENT

We would like to express our gratitude to CONACYT, Tijuana Institute of Technology for the facilities and resources granted for the development of this research.

(Received June 1, 2017)

## REFERENCES

---

- [1] M. E. Abdelaal, H. M. Emar, and A. Bahgat: Interval type 2 fuzzy sliding mode control with application to inverted pendulum on a cart. In: 2013 IEEE International Conference on Industrial Technology (ICIT), pp. 100–105. DOI:10.1109/icit.2013.6505655
- [2] L. Amador-Angulo and O. Castillo: Optimization of the Type-1 and Type-2 fuzzy controller design for the water tank using the Bee Colony Optimization. In: 2014 IEEE Conference on Norbert Wiener in the 21st Century (21CW), 2014, pp. 1–8. DOI:10.1109/norbert.2014.6893876
- [3] C. Caraveo, F. Valdez, and O. Castillo: Optimization of fuzzy controller design using a new bee colony algorithm with fuzzy dynamic parameter adaptation. *Appl. Soft Comput.* *43* (2016), 131–142. DOI:10.1016/j.asoc.2016.02.033
- [4] O. Castillo, L. Amador-Angulo, J. R. Castro, and M. Garcia-Valdez: A comparative study of type-1 fuzzy logic systems, interval type-2 fuzzy logic systems and generalized type-2 fuzzy logic systems in control problems. *Inf. Sci.* *354* (2016), 257–274. DOI:10.1016/j.ins.2016.03.026
- [5] U. Farooq, J. Gu, and J. Luo: On the interval type-2 fuzzy logic control of ball and plate system. In: 2013 IEEE International Conference on Robotics and Biomimetics (ROBIO), pp. 2250–2256. DOI:10.1109/robio.2013.6739804
- [6] M. A. C. Fernandes: Fuzzy controller applied to electric vehicles with continuously variable transmission. *Neurocomputing* *214* (2016), 684–691. DOI:10.1016/j.neucom.2016.06.051
- [7] H. Hagrass: Type-2 FLCs: A new generation of fuzzy controllers. *IEEE Comput. Intell. Mag.* *2* (2007), 1, 30–43. DOI:10.1109/mci.2007.357192
- [8] M. A. Hannan, Z. A. Ghani, A. Mohamed, and M. N. Uddin: Real-time testing of a fuzzy-logic-controller-based grid-connected photovoltaic inverter system. *IEEE Trans. Ind. Appl.* *41* (2015), 6, 4775–4784. DOI:10.1109/tia.2015.2455025
- [9] H. M. Hasanien and M. Matar: A fuzzy logic controller for autonomous operation of a voltage source converter-based distributed generation system. *IEEE Trans. Smart Grid* *6* (2015), 1, 158–165. DOI:10.1109/tsg.2014.2338398
- [10] S. A. Hoseini and B. Labibi: Robust fuzzy controller design with bounded control effort for nonlinear systems with parametric uncertainties. In: 2009 International Conference on Networking, Sensing and Control, 2009, pp. 118–123. DOI:10.1109/icnsc.2009.4919257
- [11] S. Hassan, A. Khosravi, J. Jaafar, and M. A. Khanesar: A systematic design of interval type-2 fuzzy logic system using extreme learning machine for electricity load demand forecasting. *Energy Build.* *127* (2016), 95–104.

- [12] E. Kamal, A. Aitouche, and O. Kuzmych: Robust fuzzy controller for photovoltaic maximum power point tracking. In: 21st Mediterranean Conference on Control and Automation 2013, pp. 1304–1309. DOI:10.1109/med.2013.6608888
- [13] N. N. Karnik and J. M. Mendel: Centroid of a type-2 fuzzy set. *Inf. Sci.* *132* (2001), 1–4, 195–220. DOI:10.1016/s0020-0255(01)00069-x
- [14] N. N. Karnik, J. M. Mendel, and Q. Liang: Type-2 fuzzy logic systems. *IEEE Trans. Fuzzy Syst.* *7* (1999), 6, 643–658. DOI:10.1109/91.811231
- [15] Q. Liang and J. M. Mendel: Interval type-2 fuzzy logic systems: theory and design. *IEEE Trans. Fuzzy Syst.* *8* (2000), 5–6, 535–550. DOI:10.1109/91.873577
- [16] J. Liu, W. Zhang, X. Chu, and Y. Liu: Fuzzy logic controller for energy savings in a smart LED lighting system considering lighting comfort and daylight. *Int. J. Electr. Power Energy Syst.* *82* (2016), 1–10.
- [17] J. Liu, W. Zhang, X. Chu, and Y. Liu: Fuzzy logic controller for energy savings in a smart LED lighting system considering lighting comfort and daylight. *Energy Build.* *127* (2016), 95–104. DOI:10.1016/j.enbuild.2016.05.066
- [18] M. J. Mahmoodabadi and H. Jahanshahi: Multi-objective optimized fuzzy-PID controllers for fourth order nonlinear systems. *Eng. Sci. Technol. Int. J.* *19* (2016), 2, 1084–1098. DOI:10.1016/j.jestch.2016.01.010
- [19] E. H. Mamdani: Application of fuzzy algorithms for control of simple dynamic plant. *Proc. Inst. Electr. Eng.* *121* (1974), 12, 1585–1588. DOI:10.1049/piee.1974.0328
- [20] M. S. Masmoudi, N. Krichen, M. Masmoudi, and N. Derbel: Fuzzy logic controllers design for omnidirectional mobile robot navigation. *Appl. Soft Comput.* *45* (201), 901–919. DOI:10.1016/j.asoc.2016.08.057
- [21] M. S. Masmoudi, N. Krichen, M. Masmoudi, and N. Derbel: Fuzzy logic controllers design for omnidirectional mobile robot navigation. *Appl. Soft Comput.* *49* (2016), 901–919. DOI:10.1016/j.asoc.2016.08.057
- [22] P. Melin, C. I. Gonzalez, J. R. Castro, O. Mendoza, and O. Castillo: Edge-Detection Method for Image Processing Based on Generalized Type-2 Fuzzy Logic. *IEEE Trans. Fuzzy Syst.* *22* (2014), 6, 1515–1525. DOI:10.1109/TFUZZ.2013.2297159
- [23] J. M. Mendel and R. I. B. John: Type-2 fuzzy sets made simple. *IEEE Trans. Fuzzy Syst.* *10* (2002), 2, 117–127. DOI:10.1109/91.995115
- [24] J. M. Mendel, F. Liu, and D. Zhai: Alpha-Plane Representation for Type-2 Fuzzy Sets: Theory and Applications. *IEEE Trans. Fuzzy Syst.* *17* (2009), 5, 1189–1207. DOI:10.1109/TFUZZ.2009.2024411
- [25] A. R. Ofoli and A. Rubaai: Real-Time Implementation of a Fuzzy Logic Controller for Switch-Mode Power-Stage DC - DC Converters. *IEEE Trans. Ind. Appl.* *42* (2006), 6, 1367–1374. DOI:10.1109/tia.2006.882669
- [26] K. Premkumar and B. V. Manikandan: Bat algorithm optimized fuzzy PD based speed controller for brushless direct current motor. *Eng. Sci. Technol. Int. J.* *19* (2016), 2, 818–840. DOI:10.1016/j.jestch.2015.11.004
- [27] M. A. Sanchez, O. Castillo, and J. R. Castro: Generalized Type-2 Fuzzy Systems for controlling a mobile robot and a performance comparison with Interval Type-2 and Type-1 Fuzzy Systems. *Expert Syst. Appl.* *42* (2015), 14, 5904–5914. DOI:10.1016/j.eswa.2015.03.024

- [28] M. Singh, P. Kumar, and I. Kar: Implementation of vehicle to grid infrastructure using fuzzy logic controller. *IEEE Trans. Smart Grid* 3 (2012), 1, 565–577. DOI:10.1109/tsg.2011.2172697
- [29] D. A. R. Wati: Maximum power point tracking of photovoltaic systems using simple interval type-2 fuzzy logic controller based on hill climbing algorithm. In: 2016 International Seminar on Intelligent Technology and Its Applications (ISITIA), pp. 687–692. DOI:10.1109/isitia.2016.7828743
- [30] D. Wu: On the fundamental differences between interval Type-2 and Type-1 fuzzy logic controllers. *IEEE Trans. Fuzzy Syst.* 20 (2012), 5, 832–848. DOI:10.1109/TFUZZ.2012.2186818
- [31] L. A. Zadeh: Fuzzy logic = computing with words. *IEEE Trans. Fuzzy Syst.* 4 (1996), 2, 103–111. DOI:10.1109/91.493904

*Emanuel Ontiveros-Robles, Division of Graduate Studies, Tijuana Institute of Technology, Tijuana 22414. Mexico.*

*e-mail: emanuel99ontiveros@gmail.com*

*Patricia Melin, Division of Graduate Studies, Tijuana Institute of Technology, Tijuana 22414. Mexico.*

*e-mail: pmelin@tectijuana.mx*

*Oscar Castillo, Division of Graduate Studies, Tijuana Institute of Technology, Tijuana 22414. Mexico.*

*e-mail: ocastillo@tectijuana.mx*



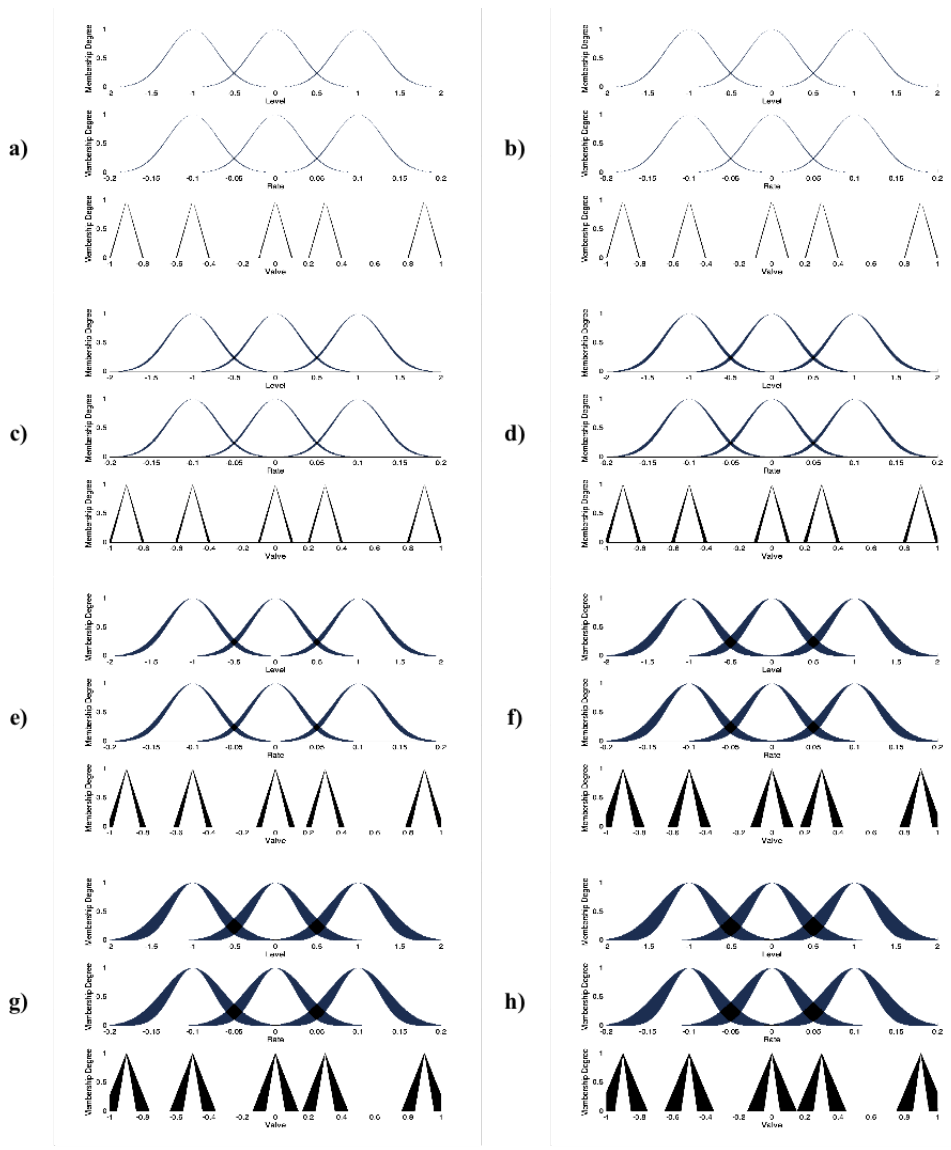

Fig. 11. Fuzzy sets of the IT2 FLC controllers of Table 2.

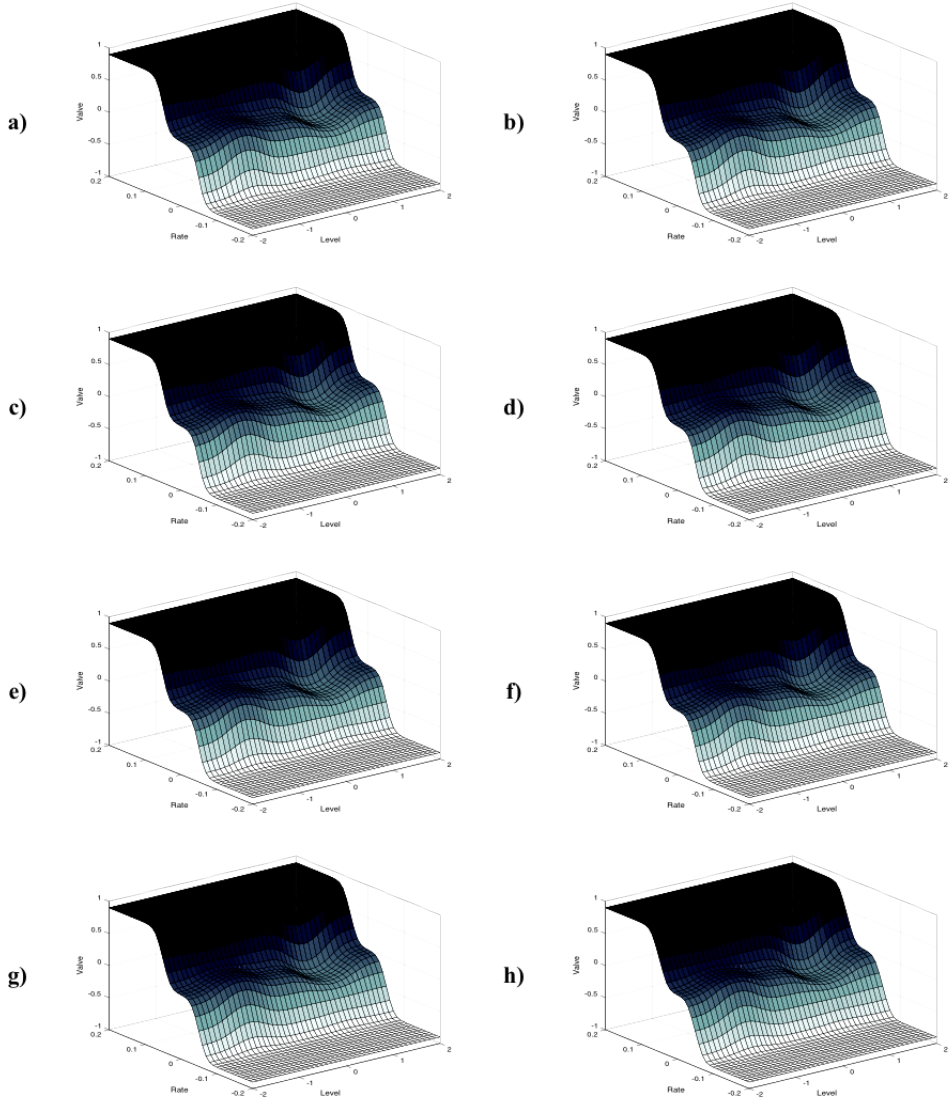

Fig. 12. Control surfaces of the IT2 FLC controllers of Table 2.

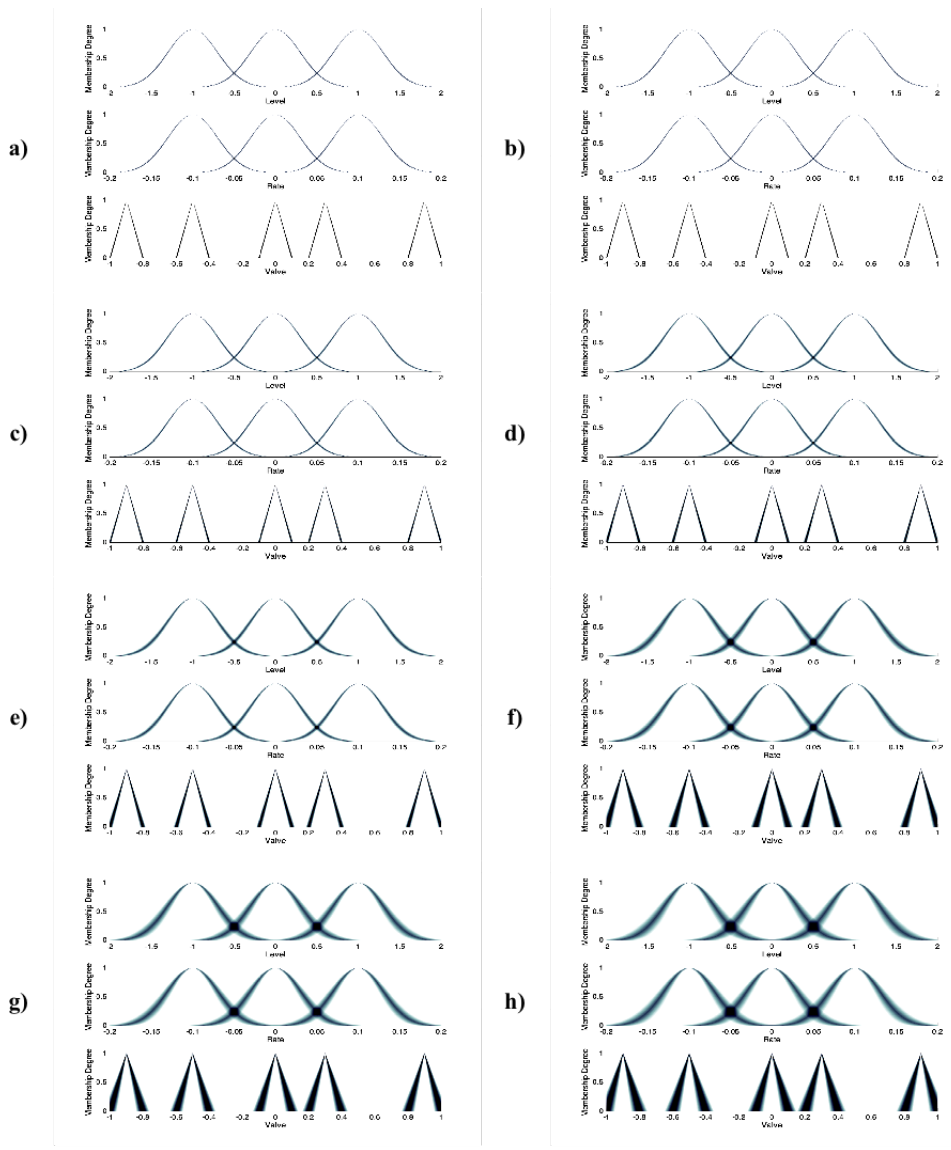

Fig. 13. Fuzzy sets of the GT2 FLC controllers of Table 2.

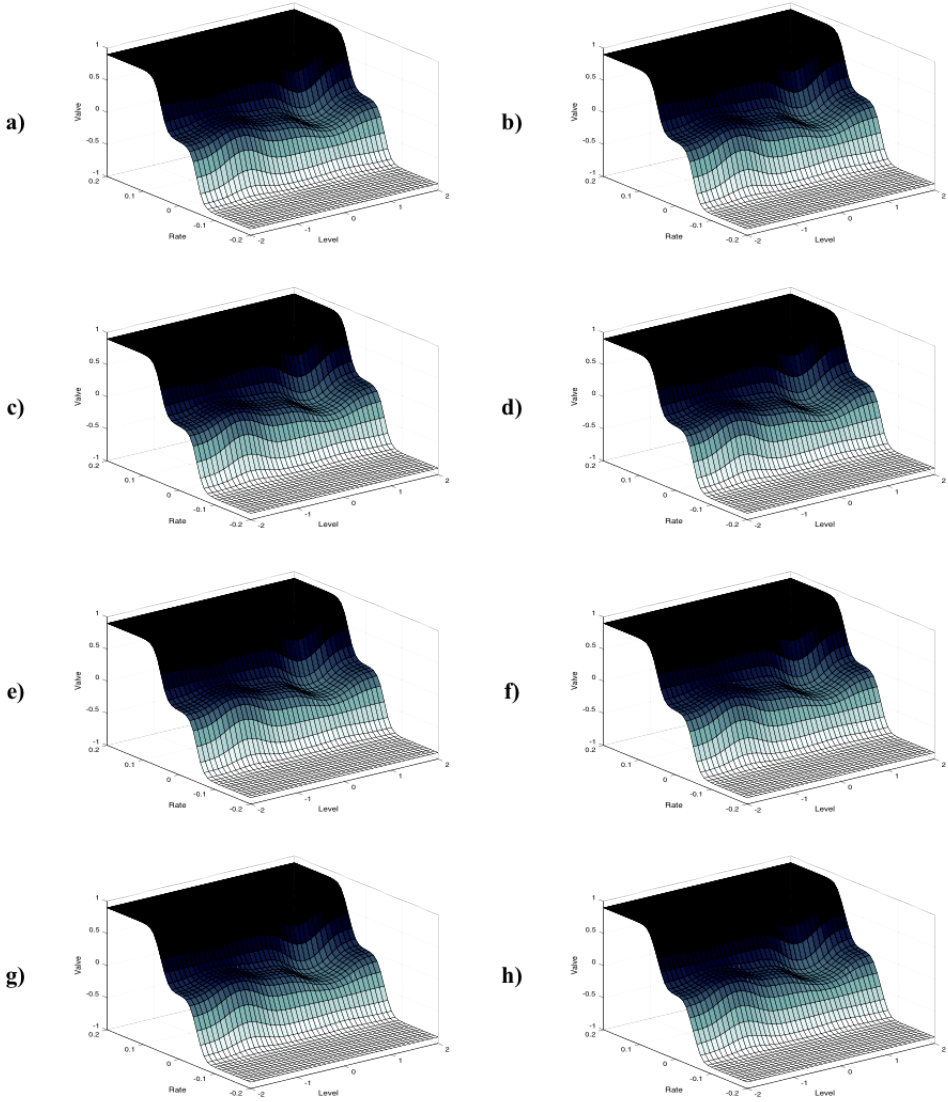

Fig. 14. Control surfaces of the GT2 FLC controllers of Table 2.

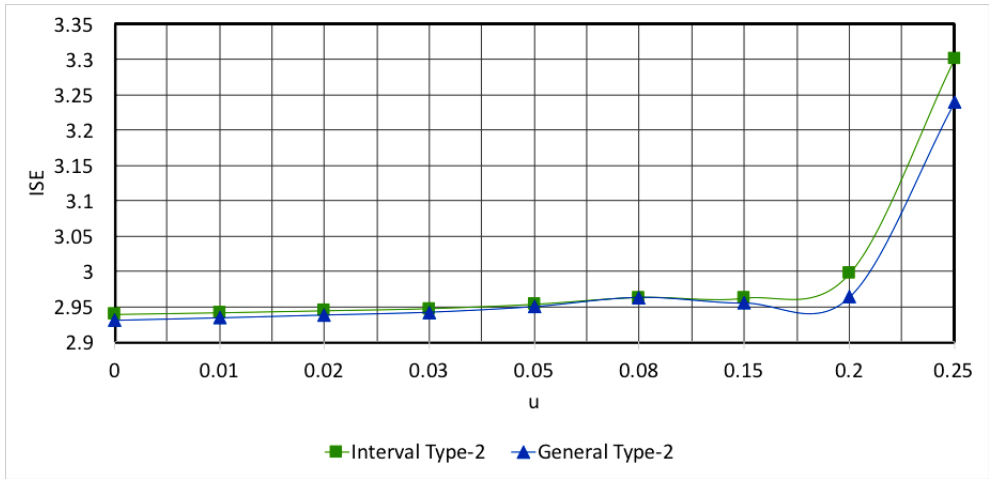

Fig. 15. ISE comparison for IT2 FLCs and GT2 FLCs.

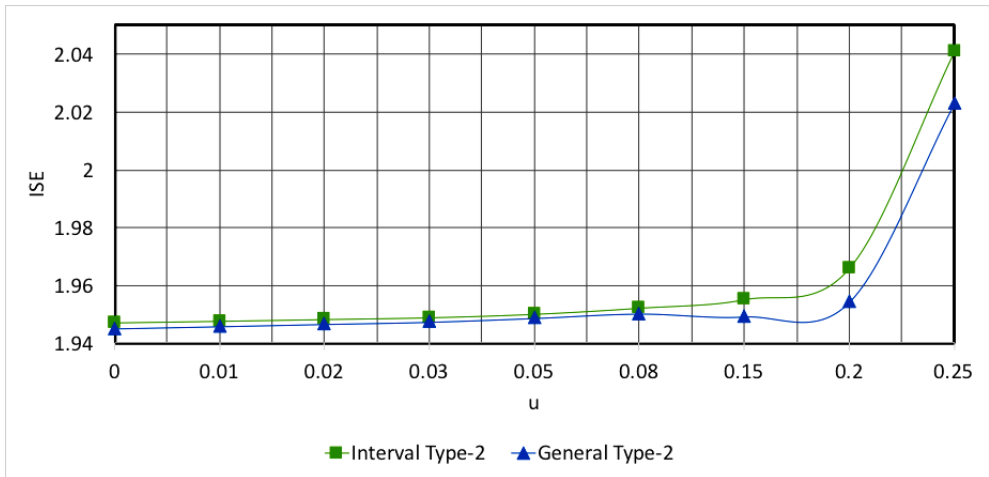

Fig. 16. IAE comparison for IT2 FLCs and GT2 FLCs.

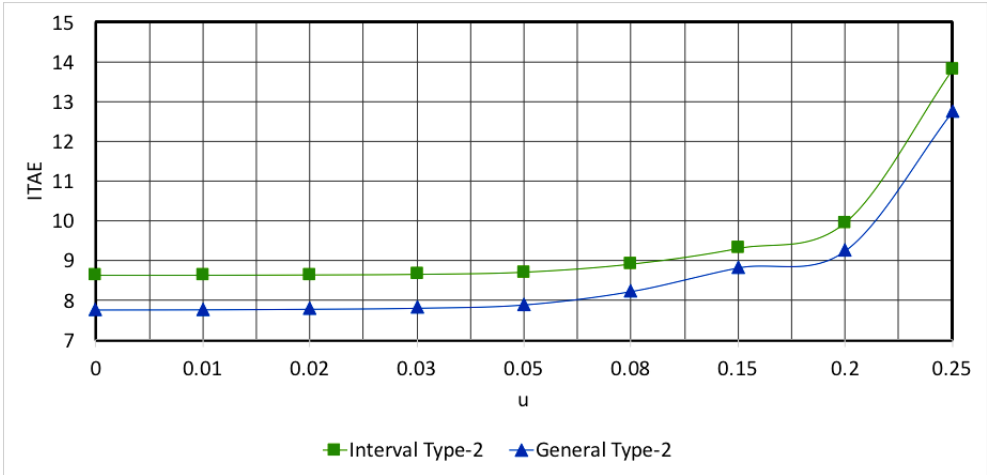

Fig. 17. ITAE comparison for the IT2 FLCs and GT2 FLCs.

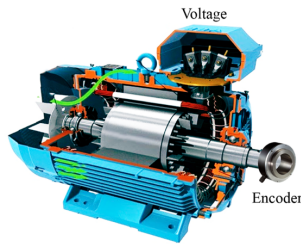

Fig. 18. Plant 2 graphical representation.

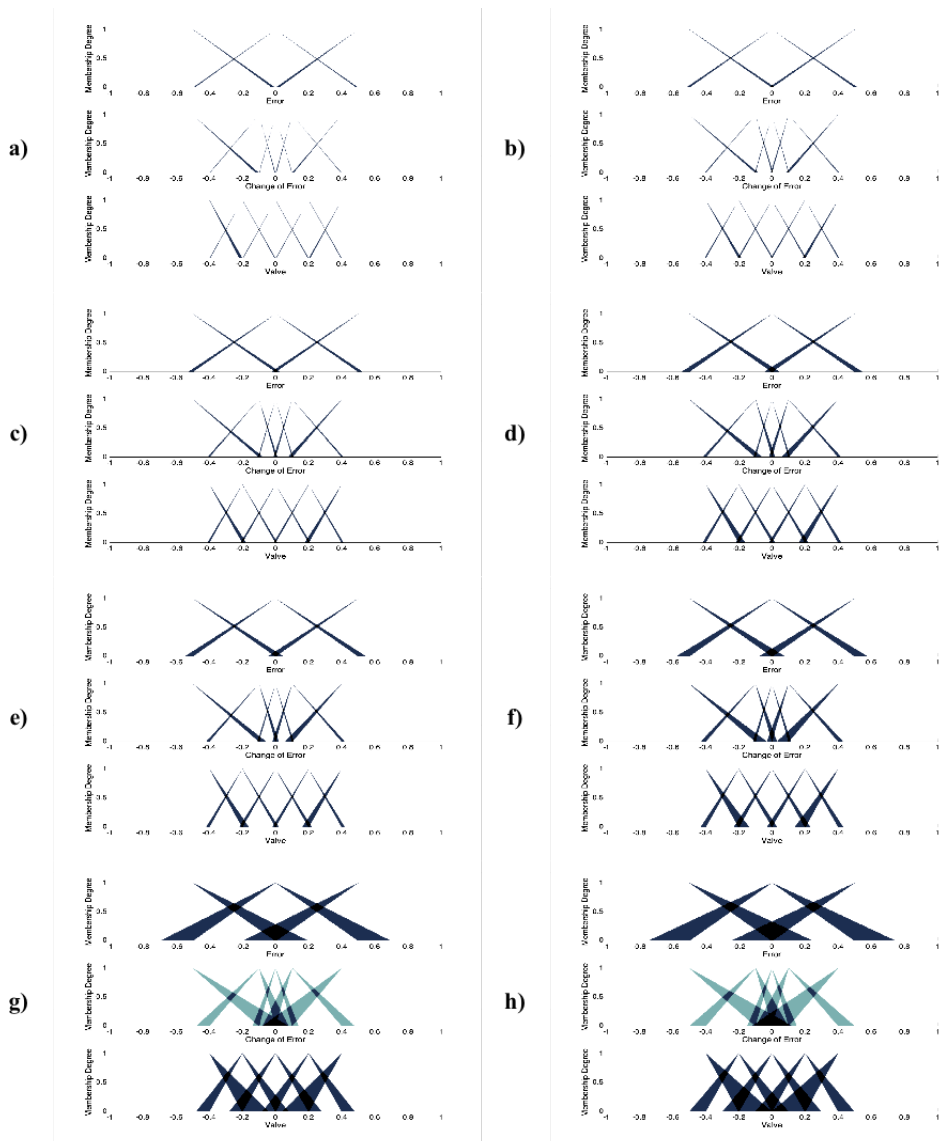

Fig. 19. Fuzzy sets of the IT2 FLC controllers of Table 2.

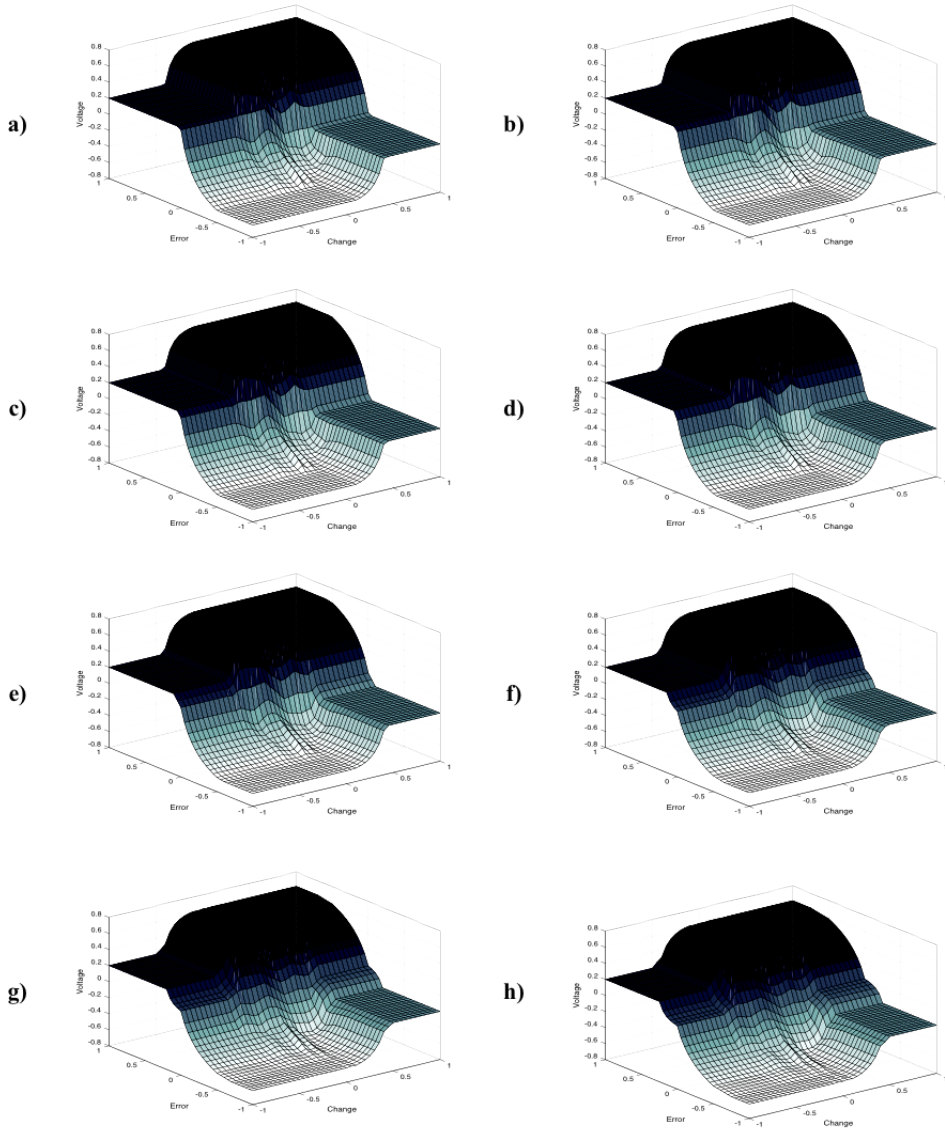

Fig. 20. Control surfaces of the IT2 FLC controllers of Table 2.



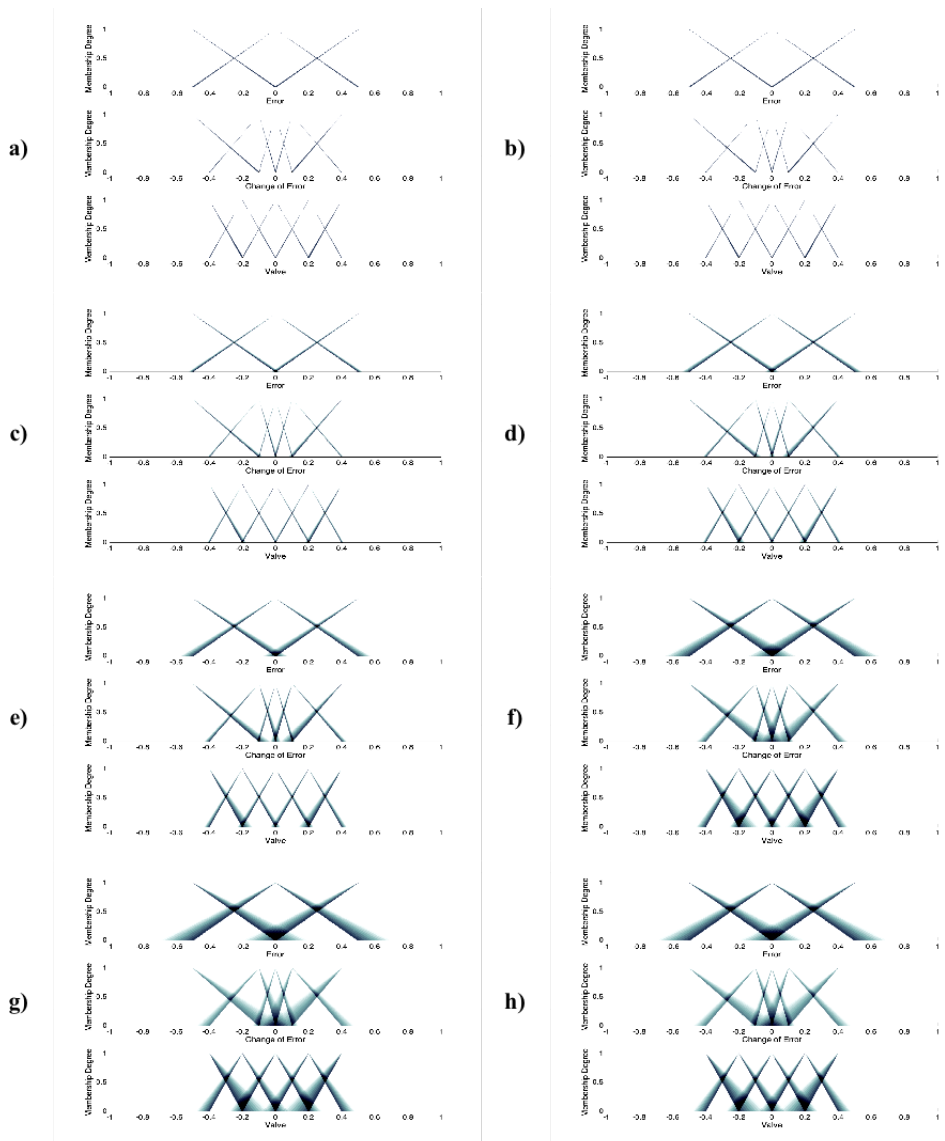

Fig. 21. Fuzzy sets of the GT2 FLC controllers of Table 2.

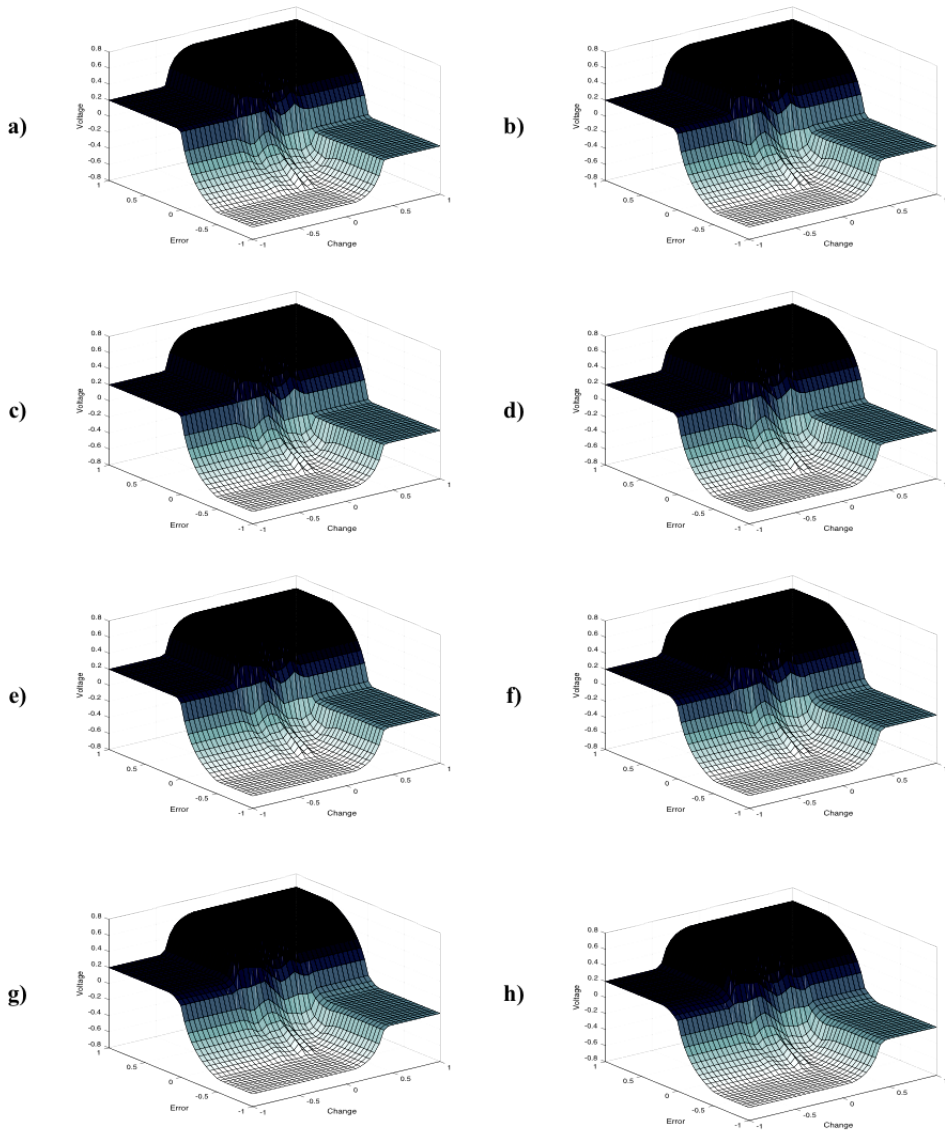

Fig. 22. Control surfaces of the GT2 FLC controllers of Table 2.

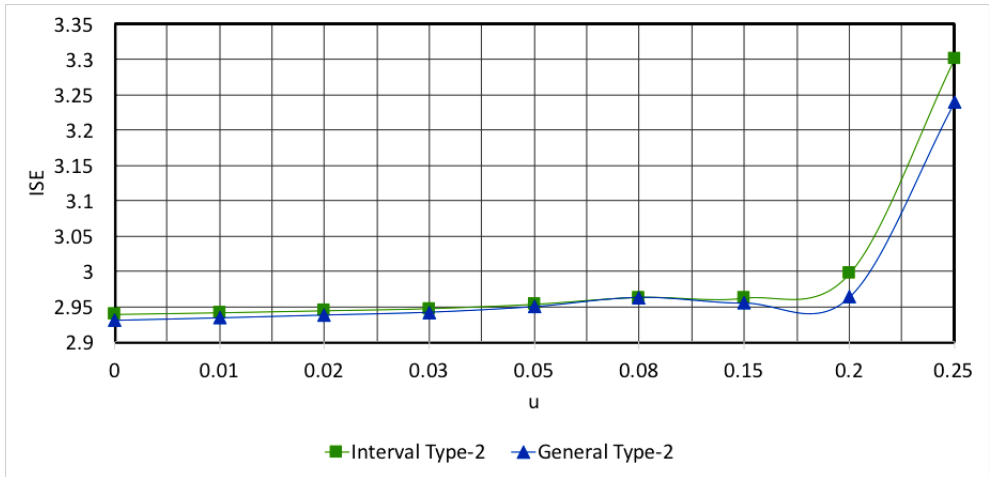

Fig. 23. ISE comparison of the IT2 FLCs and GT2 FLCs.

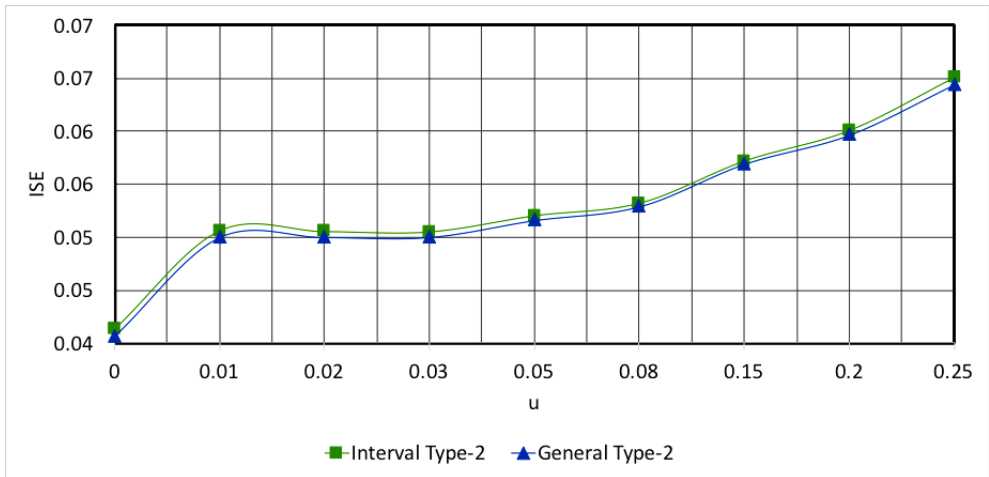

Fig. 24. IAE comparison of the IT2 FLCs and GT2 FLCs.

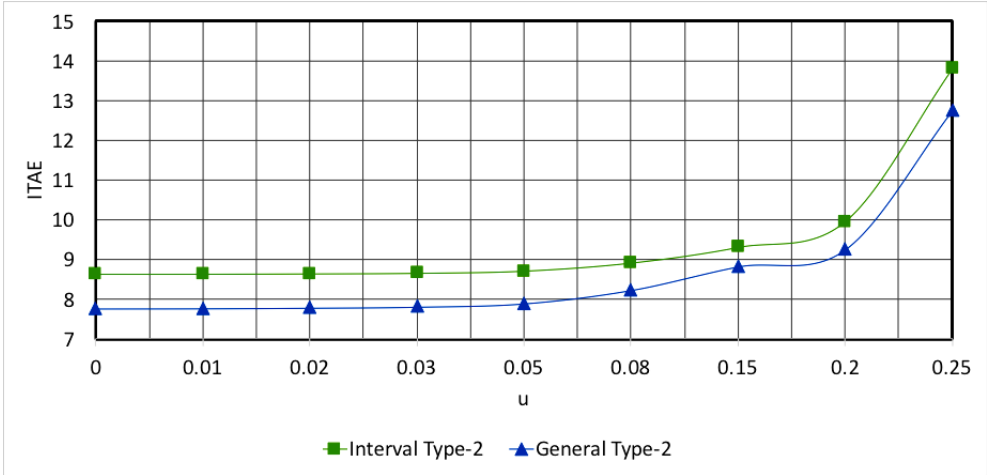

Fig. 25. ITAE comparison of IT2 FLCs and GT2 FLCs.

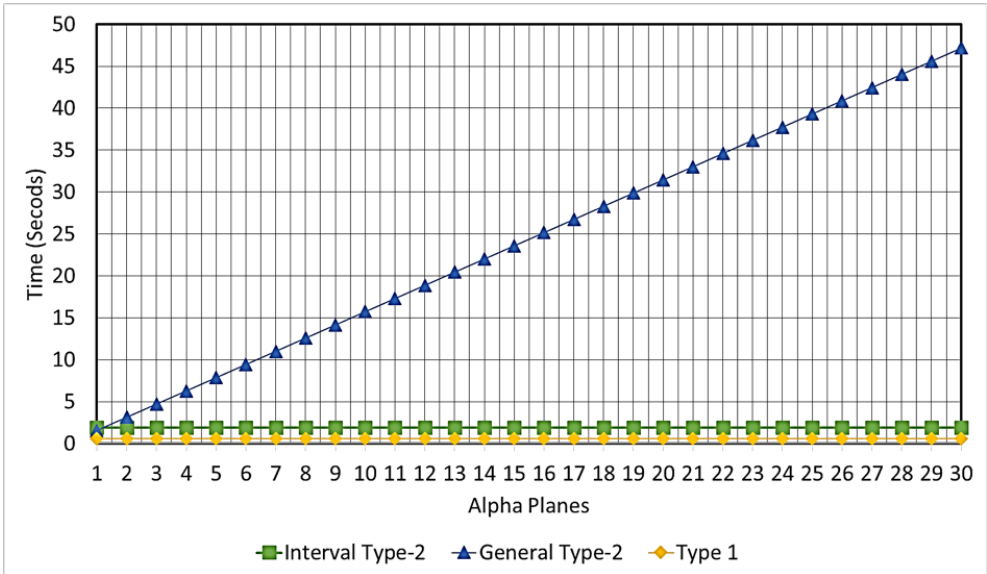

Fig. 26. Response Time vs Number of Alpha-planes (+ GT2 , x IT2 and  $\zeta$  T1).